

Data Sheet

MF_ICBprot_030518.pdf

43 Pages

Last Revised 03/05/2018

Micro RWD MF-IC (Mifare/ICODE/ISO14443B) Reader (low power version with auxiliary outputs)

The MicroRWD MF-IC module is a complete “contactless” read / write solution for 13.56 MHz Mifare Classic (1k, 4k, Ultralight, ProX, Smart MX, JCOP), ICODE SLI (including Tag-it HF-I) and ISO14443B (Calypso Rev2) cards and tags. DESfire, Mifare PLUS and ISO14443B Calypso cards are supported for serial number acquisition only. The solution is entirely housed within a 24-pin DIL package and only needs an antenna connected and a 5v DC supply to be a fully featured ISO14443A and ISO15693 Reader system. The MicroRWD MF-IC (low power) version behaves in the same manner as other IBT RWD (**Read/Write Devices**) except that it has an **average current consumption of down to 150µA (micro Amps)** even when fully active (with 1 second polling rate selected). Internal EEPROM memory is used to store Authentication keys, lists of authorised serial numbers and configuration parameters. The MicroRWD MF-IC is pin compatible with previous IBT RWD modules and has LED drives to give visual indication of acceptance and a simple TTL level RS232 interface for all commands and data response.

In addition, the RWD MF-IC version has a programmable “BEEP” output for external control and **auxiliary data outputs on the OP0 / OP1 pins**. These can be programmed to automatically output UID (serial number) or other block data as **asynchronous 9600 baud** serial or **Wiegand protocol Data High / Data Low signals**. All these features can be configured and turned ON/OFF by setting RWD EEPROM parameters. The diagram below shows the pin out configuration for the MicroRWD MF-IC module.

Micro RWD MF-IC module connections

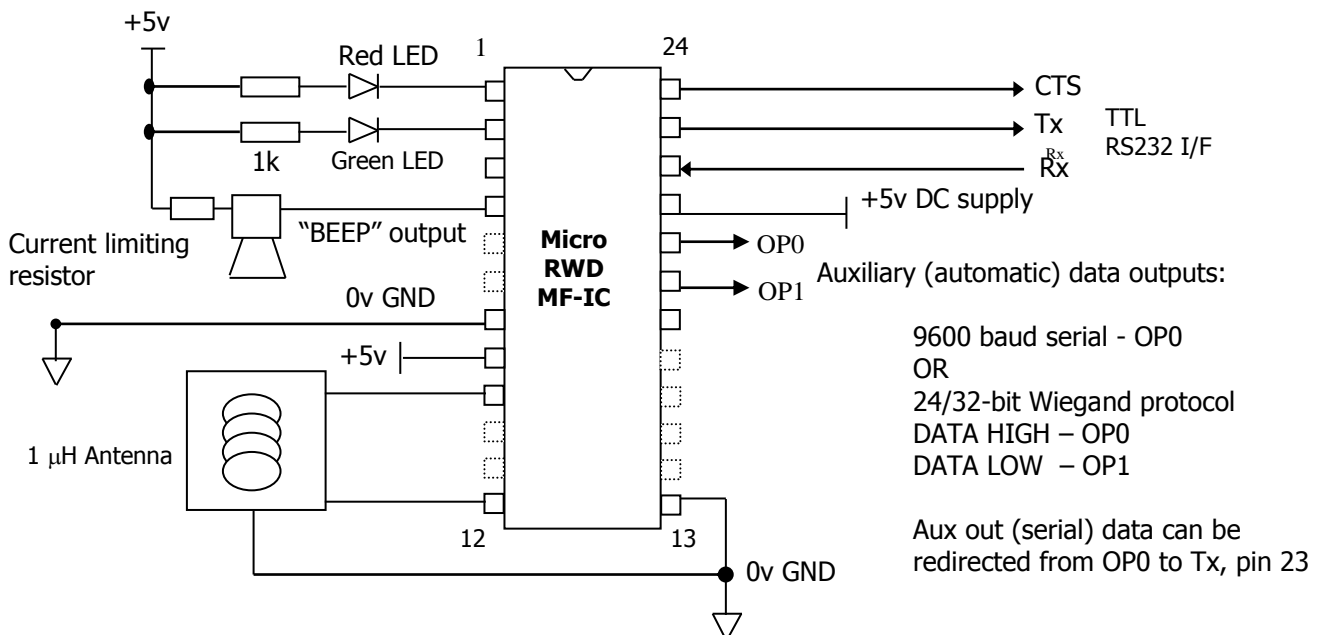

MicroRWD MF-IC operation

The MicroRWD MF-IC is a proximity system and a Read/Write range of up to 10cm can be achieved under ideal conditions using the appropriate antenna. For evaluation purposes the RWD is available on a base-board with LEDs, 9-pin RS232 socket and optional USB interface fitted. When power (5v DC) is first applied to the board the red and green LEDs flash once to indicate successful power-up (both LEDs stay on if initialisation fails). The RWD can also check for internal faults and error conditions, these problems are indicated by the red LED or both LEDs flashing continuously until the fault has been rectified.

The RWD will normally have the red LED ON until a valid card is brought into the RF field. If the tag is accepted as valid then the green LED is turned ON (and red OFF) and the auxiliary and BEEP outputs are handled (if selected).

Auxiliary Data Output

The Micro RWD MF-IC uses the 4-byte UID (serial number) or the least significant (first) 4-bytes of data from Mifare/ICODE/ISO14443B (Calypso) card memory block to create a 32-bit data frame. The data frame can then be output as asynchronous 9600 baud serial data on OP0 pin or as 24 / 32 bit Wiegand protocol with parity bits attached (making 26 or 34 bits of data) on OP0 / OP1 pins.

An RWD EEPROM parameter can redirect the serial auxiliary output on OP0 (pin 20) to the main TX output (pin 23). This allows both bi-directional command/data communication and the automatic auxiliary serial data output with the same 3-wire RS232 interface.

Note that when the auxiliary serial output has been redirected to TX pin, there will be NO acknowledgement or data response to commands (to avoid confusion of data).

For normal command and data response, the serial auxiliary output MUST be directed to the OP0 pin or turned OFF.

The auxiliary data outputs on OP0 / OP1 are **AUTOMATIC** and if enabled, occur when a card enters the RF field for the first time. The “BEEP” output signal delay, data source, byte order and Hex/ASCII format for the auxiliary output and the various Wiegand protocol options are all controlled by programmable RWD EEPROM parameters (see page 8). A zero data length parameter effectively turns the auxiliary outputs OFF.

The MicroRWD can be used in battery powered application (down to 150µA average current consumption) and automatically output blocks of data (such as the UID) **WITHOUT** any commands being sent to the module. In addition, the “Green” LED output or the BEEP output can be used as a control signal to “interrupt” the host computer or microcontroller just before the automatic data is transmitted.

NOTE that the “BEEP” output (RWD pin 4) idles in a high state and “sinks” current. External loads can be connected between 5-volt supply and pin 4 with a series resistor to ensure “sink” current does not exceed 25ma.

Note that setting Polling rate parameter to minimum value (0x00) means the polling rate is always as fast as possible and does not change (“SLEEP” and power-down is skipped).

Mifare Transponders

The Mifare transponders are available with 64 bytes (Mifare Ultralight), 1024 bytes (Mifare 1k) and 4096 bytes (Mifare 4k) of memory and the 13.56 MHz carrier frequency provides fast transaction times of 106 kbaud.

For the 1k and 4k cards the memory is organised as 16 and 40 Sectors respectively, each Sector has 4 x 16-byte Blocks of memory (3 of which are available for general Read/Write use). Each Sector can be separately locked/unlocked for access using security keys.

Initial communication with the cards can only proceed after mutual authentication between the RWD and the card has succeeded (as defined by ISO 14443A standard). Combined with the “Security Key” access control for the memory sectors and encrypted data streams, the Mifare cards are ideally suited to Electronic-Purse applications such as ticketing and vending applications where each sector can hold entirely separate data for different applications.

Note: Some ISO14443A compliant cards have a SINGLE (4-byte) UID and others have a DOUBLE (7-byte) UID. These serial numbers are acquired as part of the initial anticollision / select procedure when a card is brought into the RF field. This UID information can be reported using the CARD UID command (or automatically output via auxiliary OP pins). The correct security keycodes will be required for subsequent card read/write operations.

This means that the Mifare UID/serial number is always readable even if correct keycodes are not known. For many applications, UID/serial number information is all that is required.

ICODE SLI Transponders

The ICODE SLI (and Tag-it HF-I) transponders support the ISO15693 standard and have 128 bytes of memory organised as 4-byte blocks (UID/serial number is 8-bytes long). Fast communication times of up to 52kbaud and the low cost of these transponders has allowed their use for asset tracking applications.

(multi-tag INVENTORY command NOT implemented on standard proximity system).

ISO14443B Transponders

The ISO14443B transponders (such as Calypso Rev2 types) are supported for serial number acquisition only. Communication with the card is according to ISO14443B specification at 106kbaud rate. The REQB/ATQB response contains the UID information that is stored and can be accessed using the CARD UID command or the automatic serial number output feature.

MicroRWD MF-IC modes of operation

The Micro RWD has two basic modes of operation:-

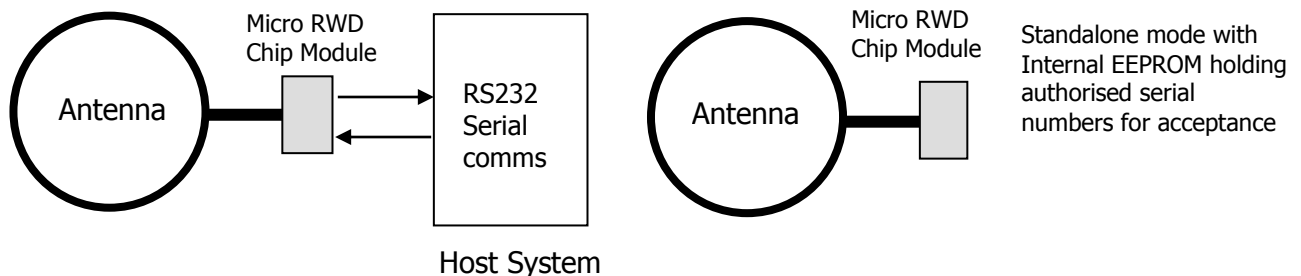

Remote mode (connected to a host computer or microcontroller) and Standalone mode.

- 1) Remote mode involves connecting to a host serial interface. This is where the stored list of authorised identity codes (serial numbers) can be empty, effectively authorising any Mifare/ICODE/ISO14443B card for subsequent read/write operations (depending on correct Security Key in Mifare case). The simple command protocol allows a host system to communicate with the Micro RWD in order to program new authorised identity codes, change parameters, load Security Keys and perform Read/Write operations to the card itself.
- 2) Standalone mode is where the Mifare/ICODE/ISO14443B card identity codes (serial numbers) are checked against a stored list of authorised codes. If an identity code is matched, the Green LED and auxiliary outputs are enabled. Effectively standalone mode occurs when there is no host system communicating with the Micro RWD. Up to 60 serial numbers can be stored in the authorisation list so this mode of operation can be used to create a “mini access control” system.

Supported transponder types

The MicroRWD MF-IC is designed to communicate with the following passive RF transponder types:-

Mifare Mode

Selected by RWD EEPROM parameter byte 3 set to 0x00 (factory default setting)

Note that Mifare cards and transponder devices are made by several companies under licence from Philips/NXP Semiconductors. They are fully Mifare compliant and only differ in having different manufacturers information in memory Block 0 :-

- 1) Mifare standard 1k card (MF1 IC S50 transponder) and equivalent.
- 2) Mifare standard 4k card (MF1 IC S70 transponder) and equivalent.

- 3) Mifare Ultralight card (MF0 IC U1 transponder).
- 4) Mifare ProX, Smart MX (JCOP) dual-interface card types are supported to allow single or double UID to be acquired and “Mifare” operations performed across the contactless interface. DESFire, Mifare PLUS supported for serial number acquisition.
- 5) Any ISO 14443A compliant contactless card can be accessed for Serial Number acquisition. Full Read/Write access will only be possible if card fully supports Philips/NXP Semiconductors CRYPTO1 algorithm and encrypted data protocols.

The operation of the MicroRWD MF-IC and the Mifare transponders is described in more detail at the end of this document.

The “ident codes” described in this text are regarded as the four byte (SINGLE) Mifare UID (Unique Identifier/serial number) or the least significant four bytes of the seven byte (DOUBLE) Ultralight UID.

ICODE SLI Mode

Selected by RWD EEPROM parameter byte 3 set to 0x01.

Note that ICODE SLI labels are designed to comply with the ISO15693 standard. Other ISO15693 smart labels may have proprietary features such as different memory sizes and subsets of the ISO15693 command protocol. MicroRWD MF-IC has been designed to work with the most common “mandatory” ISO15693 commands as supported on ICODE.

- 1) ICODE SLI (ISO15693) smart labels (Philips/NXP Semiconductors SL2 ICS20)
- 2) Any ISO15693 smart label that supports the core ISO15693 command set and has the same memory structure and configuration bytes as the ICODE SLI type (including Texas Instruments Tag-it HF-I)

The ICODE identity code is defined as the least significant four bytes of the 8-byte UID, (effectively UID0 - UID3). Note that The UID used for the "Ident list" check is the first tag UID acquired when there are multiple tags in the field (first tag in INVENTORY list).

ISO14443B Mode

Selected by RWD EEPROM parameter byte 3 set to 0x02.

ISO14443B card types are supported for serial number acquisition only.

- 1) Calypso Rev 2 card types.
- 2) Any ISO14443B card type supporting REQB/ATQB command/response protocol at 106kbaud communication rate.

IMPORTANT NOTE: DUE TO DIFFERENCES IN THE RF CHARACTERISTICS OF MIFARE, ICODE AND ISO14443B CARDS, THE ANTENNA TUNING MAY NEED ADJUSTING TO THE BEST COMPROMISE FOR OPERATION WITH ALL TYPES.

Serial Interface

This is a basic implementation of RS232. The Micro RWD does not support buffered interrupt driven input so it must control a BUSY (CTS) line to inhibit communications from the host when it is fully occupied with card communication. It is assumed that the host (such as a PC) can buffer received data. This CTS signal must be connected to the host computer communication port to allow “hardware handshaking” or the host driver software must check the CTS signal and only send commands/data when it is in a LOW state. The CTS signal is pulsed LOW for a 6ms period each polling cycle. The host computer must wait for this LOW signal and then send the command and data.

The CTS line remains in a LOW state while the command and data bytes are being received. After the last byte of data, the CTS signal “times out” for 6ms and returns HIGH.

This 6ms “window” every polling cycle allows the host computer to send a single command and associated data to the RWD. Please note that only one command and its corresponding parameter bytes can be sent during a CTS LOW period, the command and data bytes must be sent with no gaps between, if there is a pause of more than 6ms between bytes then “time out” occurs, the CTS line returns high and the command fails (flagged as RS232 error). The CTS signal idles in this HIGH state (to inhibit host communication) until the next polling cycle begins.

The communication baud rate is 9600 baud, 8 bits, 1 stop, no parity. The RWD Tx, Rx and CTS signals are all TTL level and can be converted to +/-10v RS232 levels using a level converter device such as the MAX202 (note the inversion of the TTL levels).

The Micro RWD MF-IC (low-power) version has been specifically designed to operate with very low average power consumption but still remain responsive to cards entering and leaving the field and be able to read large amounts of data as quickly as possible.

THE RWD HAS THREE POLLING STATES:

1) NO card present and NO host commands received.

Polling cycle rate (time between subsequent CTS low periods) is determined by the “polling rate” parameter stored in the RWD EEPROM memory. This is typically set to a long period (4ms to 8 seconds, default setting 260mS) and is the primary means to reduce average power consumption. This is because most of the polling cycle period is spent in a power-down/sleep mode.

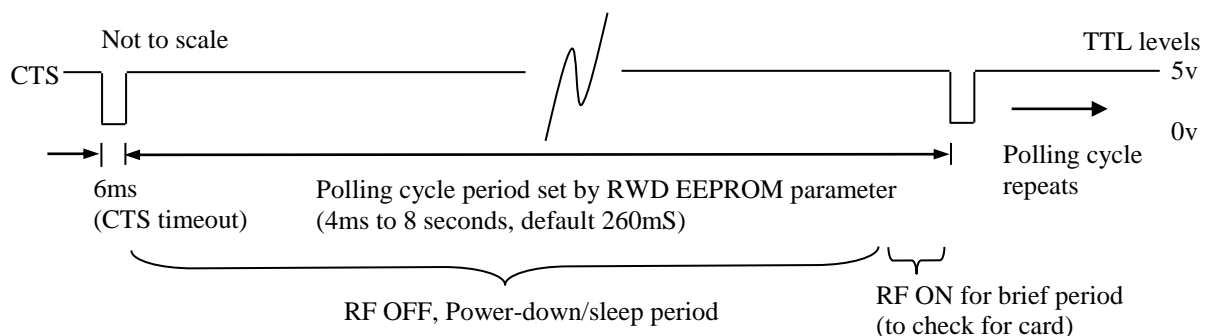

2) Mifare/ICODE card in field, NO host commands received.

When a card is detected in the field the polling rate changes to approximately 100ms (between CTS low periods). This is to ensure that the RWD can respond quickly to the card leaving the field and a new card being presented.

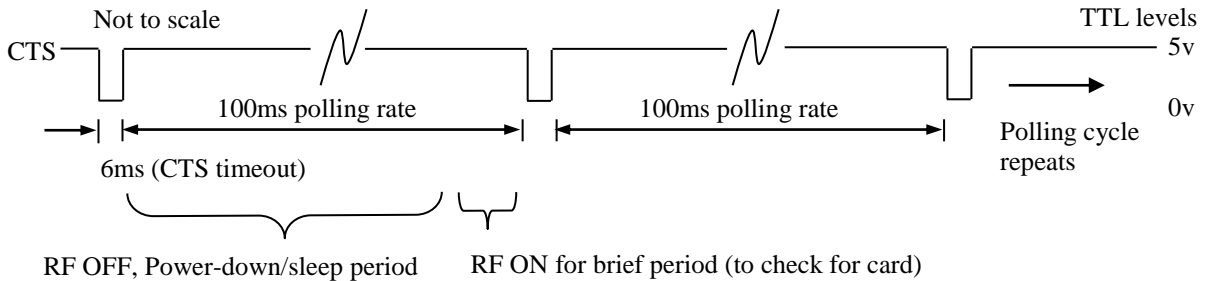

3) Host commands received and processed.

When the RWD receives commands from the host computer, the polling rate increases to allow a quick response to the command. This means that commands such as READ or WRITE BLOCK can be repeated quickly and the large amounts of data read from, or written to the card as fast as possible.

The polling cycle delay in this case is effectively the minimum, so the RWD responds to the host command immediately after the RF communication is complete.

Example a) NO card present, single CARD UID (0x55) command received.

Note: at 9600 baud serial communication rate, a single byte is received or transmitted in approximately 1mS (104µS per bit). If no commands follow then the polling rate reverts back to the stored parameter value as in (1).

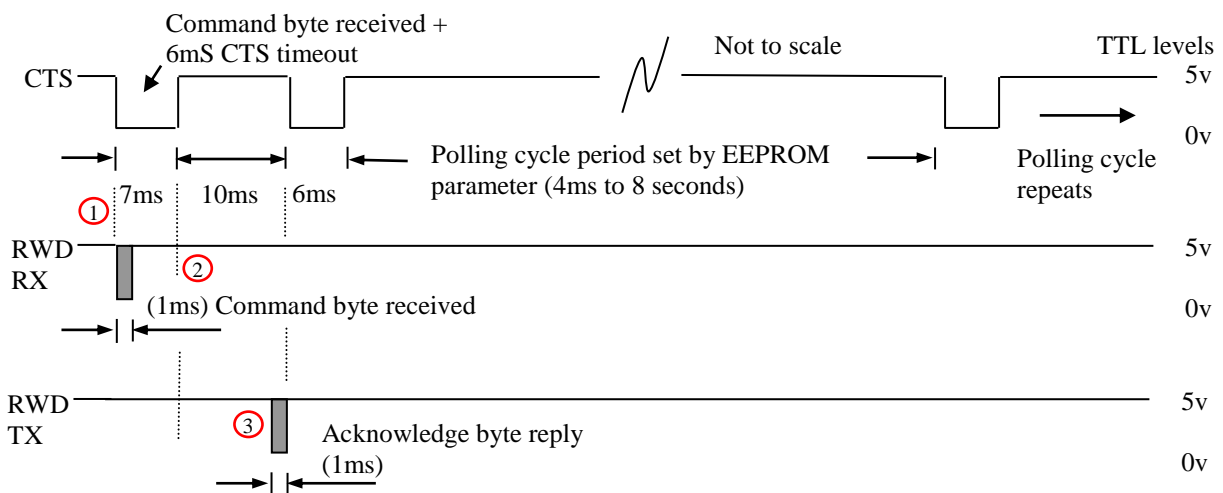

- ① Host waits for CTS falling edge then sends command byte.
- ② RWD processes command, RF turned ON for brief period to check if card present.
- ③ RWD then replies with acknowledge byte (+ data).

Example b) Mifare card in field, single CARD UID (0x55) command received.

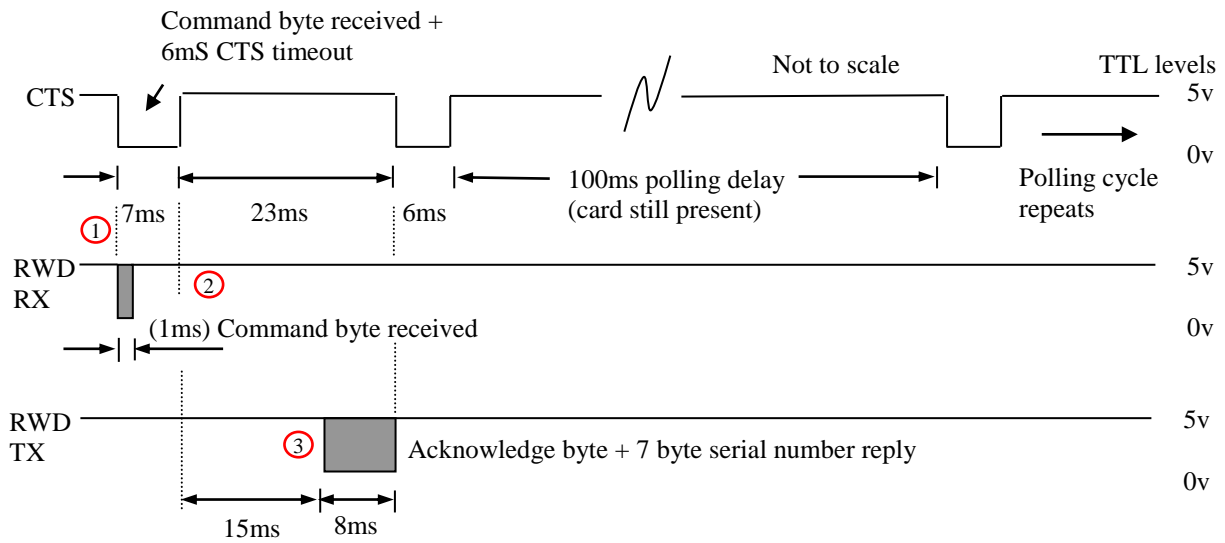

Example c) Mifare card in field, valid READ BLOCK command received (Read cmd (0x52) + Keycode number + Block number)

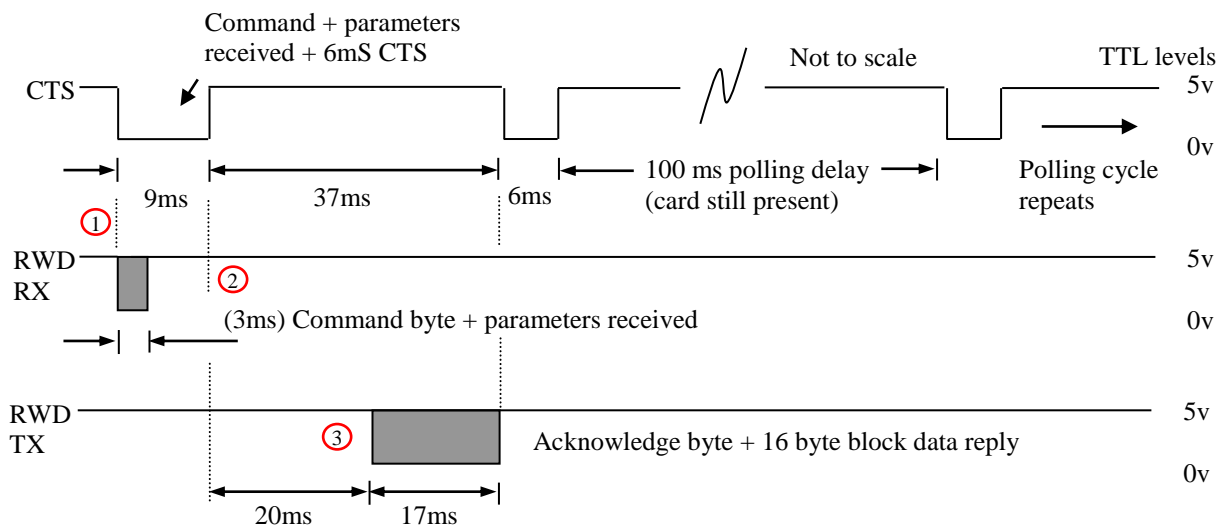

Auxiliary output and BEEP delay timing (if options are enabled)

Card in field for first time, Auxiliary output enabled and BEEP delay set. Green LED signal can be used as an interrupt signal to the host to indicate that auxiliary data will follow.

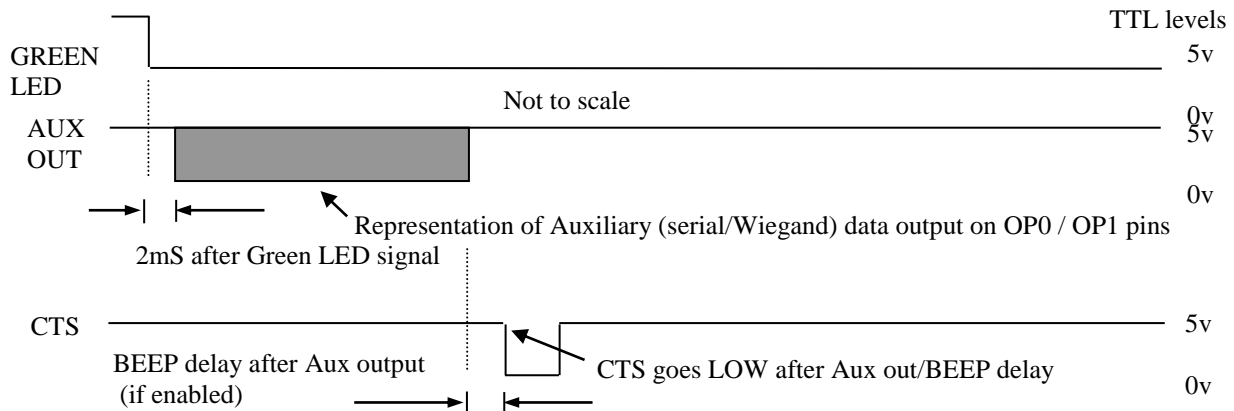

Summary of Polling rates and command timing

Three polling rates:

- 1) NO card and NO commands: Polling rate determined by Polling rate parameter in RWD EEPROM (4ms to 8 seconds, default setting 260ms)
- 2) Card present but NO commands: 100ms polling delay between CTS pulses.
- 3) Command (and parameters) received: 10ms polling delay to next CTS pulse.

For lowest power consumption, the Polling rate parameter in EEPROM is typically set to a long period (> 1 second). Auxiliary output (if enabled) occurs after Green LED signal and before CTS.

Host communication software must be able to handle the three polling rates.

Note that Auxiliary outputs (and “BEEP” output) should be turned OFF if standard RS232 command interface is being used to ensure minimum power consumption and no additional delays occur in the polling loop.

Transmitted or Received data byte, 9600 baud, 8 bit, 1 stop, No parity (104 μ S per bit)

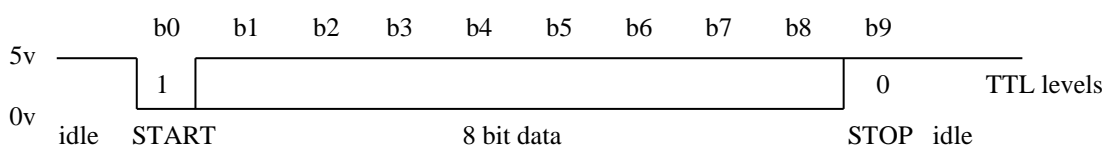

Host Driver software

Communication with the MicroRWD module is via the TTL level RS232 interface (9600 baud, 8 bit, 1 stop bit, no parity) and uses the CTS line for hardware handshaking. The Windows applications (supplied with the Evaluation kit) can be used to communicate with the module or the user can write their own application on a PC or a microcontroller. Please note that the host software must be able to handle the three distinct polling rates (different periods between CTS pulses). The following basic communication algorithm can be used:-

Typical host computer “pseudo” driver code

```
if (Green LED ON (pin 2 = 0))          // Optional check for valid tag in field
{
  if (CTS = 0)                          // Wait for CTS = 0 (RWD ready to receive command / data)
  {
    // CTS times out after 6ms so command and all parameters must be sent with
    // no gaps otherwise CTS times out and goes HIGH.
    // For example, send READ BLOCK 1 using KEY 0 as KEYA (0x52 0x01 0x00)

    SEND_BYTE( 0x52);                    // Send command
    SEND_BYTE( 0x01);                    // Send argument 1
    SEND_BYTE( 0x00);                    // Send argument 2

    // RWD sets CTS = 1 after last parameter received. RWD module processes
    // command, turns on RF for short period, waits then sends reply.

    GET_REPLY();                          // Get Acknowledge byte + data
    // Response to READ command is 0x80 (no tag) or 0x86 + sixteen bytes of DATA.
  }
}
```

Commands for MIFARE, ICODE and ISO14443B modes

These commands are common to all RWD Reader modes and have the same function, structure and arguments no matter which mode is selected.

Card / Label STATUS

Command to return card status.

The acknowledge byte flags indicate general Mifare/ICODE/ISO14443B card status.

	B7							B0	
Command:	0	1	0	1	0	0	1	1	(Ascii "S", 0x53)
Acknowledge:	1	F	F	F	F	F	F	X	(F = Status flags)

MESSAGE Report

Command to return product and firmware identifier string to host.

Command: B7 B0
 0 1 1 1 1 0 1 0 (Ascii "z", 0x7A)

Reply: "m IDE RWD Mifare ICODE (SECMFL_CWAX_LP_B V3.xx DD/MM/YY) copyright: IB
 Technology (Eccel Technology Ltd)" 0x00

Returned string identifies product descriptor, project name, firmware version number and date of last software change together with IB Technology copyright statement. Note that the string is always NULL terminated.

Program EEPROM

The Micro RWD has internal EEPROM for storing system parameters such as polling rate and authorised identity codes (serial numbers). This command sequence allows individual bytes of the EEPROM to be programmed with new data. The data is internally read back after programming to verify successful operation.

Command: B7 B0
 0 1 0 1 0 0 0 0 (Ascii "P", 0x50)
Argument1: N N N N N N N N (N = EEPROM memory location 0 - 255)
Argument2: D D D D D D D D (D = data to write to EEPROM)

Acknowledge: 1 X X X F X X F (F = Status flags)

Internal EEPROM memory map

Polling delay parameter values (EEPROM location 0):

Parameter 0 value	Polling Delay SLEEP Period
0x00	0 mS
0x10	8 mS
0x20	16 mS
0x30	32 mS
0x40	65 mS
0x50	132 mS
0x60	262 mS
0x70	524 mS
0x80	1 second
0x90	2 seconds
0xA0	4 seconds
0xB0	8 seconds

(SLEEP and power-down is skipped)

Polling delay can be set from 0 to 8 seconds to give complete control over current consumption and battery life. Note that setting Polling delay = 0x00 skips the SLEEP and power-down operation so polling is as fast as possible (and current consumption is highest).

Byte 0: Polling Delay (SLEEP / Power down) period (default = 0x60 = approx 260 milliseconds)

Byte 1: Aux data output: 0x00 = OFF (NO output from OP0 / OP1),
0x01 = 24 (26) bit, Wiegand on OP0 / OP1.
0x02 = 32 (34) bit, Wiegand on OP0 / OP1.
0x03 = 9600 baud serial from OP0 (default)

Byte 2: Reserved (Checksum)

Byte 3: Mifare/ICODE/ISO14443B option byte, MIFARE mode = 0x00 (default)
ICODE mode = 0x01, ISO14443B mode = 0x02

Byte 4: Wiegand parity option, NO Parity = 0x00 (default)
0x01 = Even/Odd parity added

Byte 5: Aux block address on card (Mifare card block address 0 – 255), default 0x01, block 1
(only used if parameter byte 8 is set to 0x01 for internal Block Read)

Byte 6: Key number / type used for internal Block Read of Aux data:
(TxxKKKKK), (T = Key type, 0 = KeyA, 1 = KeyB)
(K = Key code number, 0 - 31), default = key 0x00 used as typeA
(only used if parameter byte 8 is set to 0x01 for internal Block Read)

Byte 7: “Beep” delay parameter (x 40 mS) default = 0x00 (OFF)

Byte 8: Aux output source data selection.
0x00 = use UID / serial number (default)
0x01 = perform Block Read

Byte 9: Aux out (serial data) redirection (OP0 - pin 20 or Tx – pin 23)
0x00 = Serial aux output from OP0 pin (default)
0x01 = Serial aux output from main Tx pin

Byte 10: Aux output serial format (Hex or ASCII), HEX output = 0x00 (default)
ASCII output = 0x01

Byte 11: Aux output byte order option, plain data as read from card = 0x00 (default)
Byte order reversed = 0x01

Start of authorised card codes. List is terminated with FF FF FF FF sequence.

List is regarded as empty (all identity codes valid) if first code sequence in list is (FF FF FF FF).

List can hold up to 60 identity codes (serial numbers)

Byte 12: 0xFF Empty list

Byte 13: 0xFF

Byte 14: 0xFF

Byte 15: 0xFF

Byte 16: (MSB) Tag identity code

Byte 17:

Byte 18:

Byte 19: (LSB)

-

-

-

Byte 255: Last Internal EEPROM location

Note that the polling delay parameter must be a valid value (as shown in the table above), other values will give undefined results.

Factory Default RWD EEPROM parameter settings:

Byte 0:	0x60,	260mS Polling delay / SLEEP period
Byte 1:	0x03,	Aux data output as 9600 baud serial on OP0
Byte 2:	Reserved	
Byte 3:	0x00	MIFARE mode
Byte 4:	0x00	Wiegand NO parity option (only used if Byte 1 = 0x01 / 02)
Byte 5:	0x01	Aux block address on card (only used if Byte 8 = 0x01)
Byte 6:	0x00	Key number / type used for internal Block Read of Aux data (Use Key Code 0 as Key Type A, only used if Byte 8 = 0x01)
Byte 7:	0x00	“Beep” output delay OFF
Byte 8:	0x00	Aux output source data is UID (serial number).
Byte 9:	0x00	Aux output (serial data) directed to OP0 pin.
Byte 10:	0x00	Aux output serial format, HEX byte format
Byte 11:	0x00	Aux data byte order, plain as read from card

Factory Reset

Command to restore Factory default EEPROM values and Stored Keys and perform hardware Reset operation. The 0x55 0xAA parameters protect against accidental operation. After Reset, the Red LED will flash 5 times indicating the successful loading of the Factory default values.

	B7		B0						
Command:	0	1	0	0	0	1	1	0	(Ascii “F”, 0x46)
Argument1:	0	1	0	1	0	1	0	1	0x55
Argument1:	1	0	1	0	1	0	1	0	0xAA

Reset occurs after the command is processed so there is no Acknowledge byte reply.

Command Protocol (Mifare Mode)

The following commands are supported in Mifare mode. The corresponding acknowledge code should be read back by the host and decoded to confirm that the command was received and handled correctly. The serial bit protocol is 9600 baud, 8 bits, 1 stop, no parity (lsb transmitted first).

The status flags returned in the Acknowledge byte are as follows:

b7	b6	b5	b4	b3	b2	b1	b0	
1	1	1	1	1	1	1	1	
								EEPROM error (Internal EEPROM write error)
								Card OK (Card serial number matched to identity code list)
								Rx OK (Card communication and acknowledgement OK)
								RS232 error (Host serial communication error)
								MF type (0 = MF 1k byte card, 1 = MF 4k byte card)
								UL type (0 = MF standard 1k/4k card, SINGLE UID), 1 = MF Ultralight card, DOUBLE UID)
								MFRC error (Internal or antenna fault)

Note that bit 7 is fixed so that using a Mifare 1k card, the RWD acknowledge response to a valid host command would generally be 86 (Hex), indicating that a matched (or authorised) MF 1k card is present. The MF Ultralight card has a different memory structure to the standard 1k/4k MF cards so bits 4 and 5 have to be checked to determine which card type is present. Note also that only the relevant flags are set after each command as indicated in the following specification.

Store Keys

The Micro RWD has additional internal storage for 32 Security KEYs. Six byte Key codes are required to access individual card sectors for any Read or Write operations. This command sequence allows 6 byte Key codes to be stored at any one of the 32 key code locations. Factory defaults are Infineon/Philips specified transport key pairs (Hex FF FF FF FF FF FF / Hex FF FF FF FF FF FF) and (Hex A0 A1 A2 A3 A4 A5 / Hex B0 B1 B2 B3 B4 B5) and these are stored in the RWD non-volatile memory during manufacture. Note that due to the fundamental nature of these Key codes, incorrect values may render the system inoperable. Only one or two Security key codes are required to unlock a card sector so the provision of 32 storage locations allows for many possible applications and card uses.

IT IS STRONGLY ADVISED THAT THE KEY CODES IN THE RWD AND STORED ON THE MIFARE CARD ARE NOT CHANGED UNTIL THE OPERATION OF THE MIFARE CARD SECURITY IS FULLY UNDERSTOOD.

	B7		B0						
Command:	0	1	0	0	1	0	1	1	(Ascii "K", 0x4B)
Argument1:	x	x	x	K	K	K	K	K	(K = Key code number, 0 - 31)
Argument2:	D	D	D	D	D	D	D	D	(D = data to write to EEPROM, LS byte)
Argument3:	D	D	D	D	D	D	D	D	
Argument4:	D	D	D	D	D	D	D	D	
Argument5:	D	D	D	D	D	D	D	D	
Argument6:	D	D	D	D	D	D	D	D	
Argument7:	D	D	D	D	D	D	D	D	(D = data to write to EEPROM, MS byte)
Acknowledge:	1	X	X	X	F	X	X	F	(F = Status flags)

Internal Key Storage memory map (default settings)

Location 0 (0x00):	Key code 0 (Default 0xFF FF FF FF FF FF)
Location 1 (0x01):	Key code 1 (Default 0xFF FF FF FF FF FF)
Location 2 (0x02):	Key code 2 (Default 0xA0 A1 A2 A3 A4 A5)
Location 3 (0x03):	Key code 3 (Default 0xB0 B1 B2 B3 B4 B5)
-	
-	
-	
Location 28 (0x1C):	Key code 28 (Default 0xFF FF FF FF FF FF)
Location 29 (0x1D):	Key code 29 (Default 0xFF FF FF FF FF FF)
Location 30 (0x1E):	Key code 30 (Default 0xA0 A1 A2 A3 A4 A5)
Location 31 (0x1F):	Key code 31 (Default 0xB0 B1 B2 B3 B4 B5)

Note that Mifare cards manufactured by Infineon and other companies under licence can have default transport key codes of (0xFF FF FF FF FF FF) and Philips/NXP cards have (0xA0 A1 A2 A3 A4 A5 / 0xB0 B1 B2 B3 B4 B5) default transport keys. The MicroRWD MF has both pairs stored as factory settings to allow ease of use when the system is first used. (More information on the Mifare card memory maps and KeyA, KeyB Security Keys can be found at the end of this document).

Write Card Block

Command to write 16 bytes of data to specified Mifare block. A Block is made up of 16 bytes and there are four blocks in each card sector (sixteen blocks per sector in upper half of Mifare 4k card). Note that blocks 3, 7, 11, 15 etc are sector trailer blocks that contain Security Key data and Access bits. Writing incorrect information to these blocks can permanently disable the sector concerned. The first argument is the block number to write data to, the second argument specifies which key code (0 - 31 from the internal storage area) to use for sector authentication/unlocking and if the Security Key is to be used as a KeyA or KeyB type code. If the write was unsuccessful (invalid card, authentication failed or card out of field) then Status flags in acknowledge byte indicate error.

	B7		B0						
Command:	0	1	0	1	0	1	1	1	(Ascii "W", 0x57)
Argument1:	N	N	N	N	N	N	N	N	(N = MF Card Block Address 0 – 255)
Argument2:	T	x	x	K	K	K	K	K	(T = Key Type, 0 = KeyA, 1= KeyB) (K = Key code number, 0 – 31)
Argument3:	D	D	D	D	D	D	D	D	<div style="font-size: 3em; line-height: 1; padding: 0 10px;">}</div> 16 Bytes of data (D = MS Byte of data to write to card)
Argument4:	D	D	D	D	D	D	D	D	
Argument5:	D	D	D	D	D	D	D	D	
Argument6:	D	D	D	D	D	D	D	D	
↓									
Argument15:	D	D	D	D	D	D	D	D	
Argument16:	D	D	D	D	D	D	D	D	
Argument17:	D	D	D	D	D	D	D	D	
Argument18:	D	D	D	D	D	D	D	D	
Acknowledge:	1	F	F	F	F	F	F	X	(F = Status flags)

Note that Mifare Ultralight cards DO NOT USE Security Keys or CRYPTO Authentication and the memory is organised differently as groups of 4 bytes (Pages). Only one Page of 4 bytes can be written at a time so to maintain compatibility and a simple RWD host command set, the same command as above is used to write data to Ultralight cards. The command and arguments have the same structure but different meanings. The "Block" address is treated as a "Page Address" and the KeyType/Key number parameter is a dummy 0x00 byte. In addition the 4 bytes of data are padded out to 16 bytes with dummy 0x00 bytes.

	B7	B0	
Command:	0 1 0 1 0 1 1 1		(Ascii "W", 0x57)
Argument1:	x x x x N N N N		(N = UL Card Page Address 0 – 15)
Argument2:	0 0 0 0 0 0 0 0		(Dummy byte, 0x00)
Argument3:	D D D D D D D D		(D = LS Byte of data to write to UL card)
Argument4:	D D D D D D D D		
Argument5:	D D D D D D D D		
Argument6:	D D D D D D D D		(D = MS Byte of data to write to UL card)
Argument7 – Argument18	0 0 0 0 0 0 0 0		12 Dummy padding bytes, 0x00
Acknowledge:	1 F F F F F F X		(F = Status flags)

Read Card Block

Command to read 16 bytes of data from specified Mifare block. The first argument is the block number to read data from, the second argument specifies which key code (0 - 31 from the internal storage area) to use for sector authentication/unlocking and if the Security Key is to be used as a KeyA or KeyB type code. If the read was successful, indicated by acknowledge status flags then sixteen bytes of block data follow.

	B7	B0	
Command:	0 1 0 1 0 0 1 0		(Ascii "R", 0x52)
Argument1:	N N N N N N N N		(N = MF Card Block Address 0 – 255)
Argument2:	T x x K K K K K		(T = Key Type, 0 = KeyA, 1 = KeyB) (K = Key code number, 0 – 31)
Acknowledge:	1 F F F F F F X		(F = Status flags)

Data only follows if Read was successful

Reply1:	D D D D D D D D	}	(D = LS Byte of data Read from card)
Reply2:	D D D D D D D D		
Reply3:	D D D D D D D D		
Reply4:	D D D D D D D D		
↓			
Reply13:	D D D D D D D D	}	16 Bytes of data
Reply14:	D D D D D D D D		
Reply15:	D D D D D D D D		
Reply16:	D D D D D D D D		
			(D = MS Byte of data Read from card)

Note that as mentioned for the WRITE command, Mifare Ultralight cards DO NOT USE Security Keys or Authentication and the memory is organised differently as groups of 4 bytes (Pages).

However, unlike the Write command, 16 bytes (4 pages) can be read in a single operation. The same Read command as above is used except the "Block" address is treated as a "Page Address" and the KeyType/Key number parameter is a dummy 0x00 byte. For page numbers greater than 12, the card data wraps around to page 0 etc.

	B7	B0	
Command:	0 1 0 1 0 0 1 0		(Ascii "R", 0x52)
Argument1:	x x x x N N N N		(N = UL Card Page Address 0 – 15)
Argument2:	0 0 0 0 0 0 0 0		(Dummy byte, 0x00)

Acknowledge: 1 F F F F F F X (F = Status flags)

Data only follows if Read was successful

Reply1:	D D D D D D D D	}	(D = LS Byte of data Read from UL card)
Reply2:	D D D D D D D D		
Reply3:	D D D D D D D D		
Reply4:	D D D D D D D D		
↓		}	16 Bytes of data
Reply13:	D D D D D D D D		
Reply14:	D D D D D D D D		
Reply15:	D D D D D D D D		
Reply16:	D D D D D D D D		(D = MS Byte of data Read from UL card)

Inc Value (only operates on Value Data Structure)

Command to increment integer within a Value Data Structure. The command loads the value from the specified block address, adds the integer parameter and stores the result at the same or another block address. Note that the source block must have been formatted as a Value Block beforehand according to the data structure below, using the WRITE command. The INC Value command only operates on a "Value Block Structure" and will fail if the block configuration or the specified key type is incorrect.

Value Block Structure

Example format for value = 100 decimal (0x64), at block address 0.
(Value data stored LS byte first, ADR = block address, \overline{ADR} = inverted block address)

	0x64	00	00	00	9B	FF	FF	FF	64	00	00	00	00	FF	00	FF
Byte:	0	1	2	3	4	5	6	7	8	9	10	11	12	13	14	15
	← Value →			← Inverted Value →				← Value →			ADR		ADR			
													\overline{ADR}		\overline{ADR}	

The first argument is the source block address to load data from, the second argument specifies which key code and type to use for sector authentication (0-31 and if it is KeyA or KeyB type). The third argument specifies the destination block address where the incremented data is stored. Note that source and destination blocks must be within same authenticated sector. The four byte positive integer to add follows (least significant byte first).

	B7	B0		
Command:	0	1	0 0 1 0 0 1	(Ascii "I", 0x49)
Argument1:	N	N	N N N N N N N N	(N = MF source block address 0 – 255)
Argument2:	T	x	x K K K K K K	(T = Key Type, 0 = KeyA, 1= KeyB) (K = Key code number, 0 – 31)
Argument3:	N	N	N N N N N N N N	(N = MF destination block address 0 – 255)
Argument4:	D	D	D D D D D D D D	} (D = LS byte of integer to add) 4 byte integer
Argument5:	D	D	D D D D D D D D	
Argument6:	D	D	D D D D D D D D	
Argument7:	D	D	D D D D D D D D	
Acknowledge:	1	F	F F F F F F F X	(F = Status flags)

Dec Value (only operates on Value Data Structure)

Command to decrement integer within a Value Data Structure. The DEC Value command operates as the INC command except the integer parameter is subtracted from the loaded value. The first argument is the source block address to load data from, the second argument specifies which key code and type to use for sector authentication (0-31 and if it is KeyA or KeyB type). The third argument specifies the destination block address where the decremented data is stored. Note that source and destination blocks must be within same authenticated sector. The four byte positive integer to subtract follows (least significant byte first).

	B7	B0		
Command:	0	1	0 0 0 1 0 0	(Ascii "D", 0x44)
Argument1:	N	N	N N N N N N N N	(N = MF source block address 0 – 255)
Argument2:	T	x	x K K K K K K	(T = Key Type, 0 = KeyA, 1= KeyB) (K = Key code number, 0 – 31)
Argument3:	N	N	N N N N N N N N	(N = MF destination block address 0 – 255)
Argument4:	D	D	D D D D D D D D	} (D = LS byte of integer to subtract) 4 byte integer
Argument5:	D	D	D D D D D D D D	
Argument6:	D	D	D D D D D D D D	
Argument7:	D	D	D D D D D D D D	
Acknowledge:	1	F	F F F F F F F X	(F = Status flags)

Transfer Value (only operates on Value Data Structure)

Command to transfer (copy) Value Data Structure. The command loads the value from the specified block address and then stores the result at the same or another block address. As with INC and DEC commands the source block must have been formatted as a Value Block beforehand and the block addresses must be within same authenticated sector.

The first argument is the source block address to load data from, the second argument specifies which key code to use for sector authentication (0-31) and if it is a KeyA or KeyB code. The third argument specifies where the data is stored.

	B7		B0						
Command:	0	1	0	1	0	1	0	0	(Ascii "T", 0x54)
Argument1:	N	N	N	N	N	N	N	N	(N = MF source block address 0 – 255)
Argument2:	T	x	x	K	K	K	K	K	(T = Key Type, 0 = KeyA, 1= KeyB)
									(K = Key code number, 0 – 31)
Argument3:	N	N	N	N	N	N	N	N	(N = MF destination block address 0 – 255)
Acknowledge:	1	F	F	F	F	F	F	X	(F = Status flags)

If the Inc, Dec or Transfer function was unsuccessful (invalid card, card out of field, authentication failed or data structures are incorrect) then Status flags in acknowledge byte indicate error. Note that the value manipulation commands operate internally on the Mifare card and no data is transferred back to the MicroRWD. Note also that Ultralight cards do not support Value Data Structures or the Inc, Dec, Transfer commands.

Card UID

Command to return card status and UID (Unique Identifier or Serial number).
The acknowledge byte flags indicate general Mifare card status.

	B7		B0						
Command:	0	1	0	1	0	1	0	1	(Ascii "U", 0x55)
Acknowledge:	1	F	F	F	F	F	F	X	(F = Status flags)

Data only follows if card was selected OK with no errors detected.

Reply1:	D	D	D	D	D	D	D	D	(D = LS Byte of UID/Serial number from card)
Reply2:	D	D	D	D	D	D	D	D	
Reply3:	D	D	D	D	D	D	D	D	
Reply4:	D	D	D	D	D	D	D	D	
Reply5:	D	D	D	D	D	D	D	D	} Dummy bytes (0x00) for Mifare 1k/4k card types
Reply6:	D	D	D	D	D	D	D	D	
Reply7:	D	D	D	D	D	D	D	D	

Note that Mifare 1k and 4k cards have a four-byte serial number but Mifare Ultralight cards have a seven byte serial number. To accommodate all card types, the Card UID command returns a seven-byte field with the last three bytes padded out with 0x00 dummy bytes in the case of Mifare 1k/4k cards.

Type Identification

Command to return the **ATQA** (Answer to Request, Type A) two-byte codes and the **SAK** (Select Acknowledge) single-byte code after the complete UID has been acquired. As part of the initial communication with the Mifare card (as defined by ISO 14443A specification), the Mifare transponder responds to REQA (Request Command, Type A) with ATQA. The two-byte ATQA contains information that allows particular transponder types to be identified. Following on from this the Mifare transponder responds to the SELECT (Select Command, Type A) with SAK (Select Acknowledge, Type A). The SAK code is a single byte value that contains further information about the type of transponder and the length of the UID. The SAK value reported is the final value after all "cascade levels" and the complete UID has been acquired.

NOTE THAT ALL THE COMMUNICATION PROTOCOL IS HANDLED INTERNALLY AND THIS COMMAND IS INCLUDED FOR DIAGNOSTIC PURPOSES TO ALLOW THE USER TO DETERMINE THE EXACT TYPE OF MIFARE CARD PRESENT IN THE FIELD, IF REQUIRED.

Command: B7 B0
 0 1 1 1 1 0 0 0 (Ascii “x”, 0x78)

Acknowledge: 1 F F F F F F X (F = Status flags)

Data only follows if card was selected OK with no errors detected.

Reply1: D D D D D D D D ATQA - MSB
 Reply2: D D D D D D D D ATQA - LSB
 Reply3: D D D D D D D D SAK

	MF UL	MF 1K	MF 4K	MF DESFire	MF Prox	MF Prox	MF Prox	MF Prox	MF Prox	MF Prox
ATQA - MSB	0x00	0x00	0x00	0x03	0xXX	0xXX	0xXX	0xXX	0xXX	0xXX
ATQA - LSB	0x44	0x04	0x02	0x44	0x08	0x04	0x02	0x48	0x44	0x42

	Smart MX	Smart MX	Smart MX	Smart MX	Smart MX	Smart MX
ATQA - MSB	0xXX	0xXX	0xXX	0xXX	0xXX	0xXX
ATQA - LSB	0x08	0x04	0x02	0x48	0x44	0x42

	MF UL	MF 1K	INFINEON 1K	MF 4K	MF DESFire	MF ProX	MF ProX	MF ProX	MF ProX	MF ProX	MF ProX
SAK	0x00	0x08	0x88	0x18	0x20	0x20	0x08	0x28	0x00	0x20	0x08

	MF ProX	MF ProX	MF ProX	Smart MX	Smart MX	Smart MX	Smart MX	Smart MX	Smart MX
SAK	0x28	0x18	0x38	0x00	0x20	0x08	0x28	0x18	0x38

Note that many of the “extended” Mifare types are dual interface cards with embedded microcontrollers for running “chip and pin” applications. Depending on the card type, the memory map and protocol of the contactless Mifare card interface may be different to Mifare “classic” types. In these cases the MicroRWD will report the UID using the Card UID command but read/write operation MAY NOT be fully supported.

Command Protocol (ICODE SLI Mode)

The following commands are supported in ICODE mode. The command code followed by optional data/arguments is sent to the MicroRWD. The RWD replies with an acknowledge code (which is made up of various status flags) followed by optional data. After the command (+ data) has been sent, the acknowledge code should be read back by the host and decoded to confirm that the command was received and actioned correctly. The serial bit protocol is 9600 baud, 8 bits, 1 stop, no parity (lsb transmitted first).

The status flags returned in the Acknowledge byte are as follows:

b7	b6	b5	b4	b3	b2	b1	b0	
1	1	0	0	1	1	1	1	
								EEPROM error (Internal EEPROM write error)
								Card OK (Label serial number matched to identity code list)
								Rx OK (Label communication and acknowledgement OK)
								RS232 error (Host serial communication error)
								MFRC error (Internal or antenna fault)

Note that bit 7 is fixed so that the RWD acknowledge response to a valid host command would generally be 86 (Hex), indicating that a matched (or authorised) ICODE tag is present.

Write Label Block

Command to write 4 bytes of data to specified ICODE transponder block. The first argument is the block number to write data to (0 - 27), the next eight arguments specify the UID (Unique Identifier or serial number) of the tag to select (sent least significant byte first).

If the write was unsuccessful (invalid card, authentication failed or tag out of field) then Status flags in acknowledge byte indicate error.

	B7								B0	
Command:	0	1	0	1	0	1	1	1		(Ascii "W", 0x57)
Argument1:	x	x	x	N	N	N	N	N	N	(N = ICODE block address, 0 – 27)
Argument2:	U	U	U	U	U	U	U	U	U	(LSB, UID0)
Argument3:	U	U	U	U	U	U	U	U	U	(UID1)
Argument4:	U	U	U	U	U	U	U	U	U	(UID2)
Argument5:	U	U	U	U	U	U	U	U	U	(UID3)
Argument6:	U	U	U	U	U	U	U	U	U	(UID4)
Argument7:	U	U	U	U	U	U	U	U	U	(UID5)
Argument8:	U	U	U	U	U	U	U	U	U	(UID6)
Argument9:	U	U	U	U	U	U	U	U	U	(MSB, UID7)
Argument10:	D	D	D	D	D	D	D	D	D	(D = LS Byte of data to write to tag)
Argument11:	D	D	D	D	D	D	D	D	D	
Argument12:	D	D	D	D	D	D	D	D	D	
Argument13:	D	D	D	D	D	D	D	D	D	(D = MS Byte of data to write to tag)
Acknowledge:	1	F	F	F	F	F	F	F	X	(F = Status flags)

Read Label Block

Command to read 4 bytes of data from specified ICODE transponder block. The first argument is the block number to read data from (0 - 27), the next eight arguments specify the UID (Unique Identifier or serial number) of the tag to select (sent least significant byte first). If the write was unsuccessful (invalid card, authentication failed or tag out of field) then Status flags in acknowledge byte indicate error.

	B7		B0						
Command:	0	1	0	1	0	0	1	0	(Ascii "R", 0x52)
Argument1:	x	x	x	N	N	N	N	N	(N = ICODE block address, 0 – 27)
Argument2:	U	U	U	U	U	U	U	U	(LSB, UID0)
Argument3:	U	U	U	U	U	U	U	U	(UID1)
Argument4:	U	U	U	U	U	U	U	U	(UID2)
Argument5:	U	U	U	U	U	U	U	U	(UID3)
Argument6:	U	U	U	U	U	U	U	U	(UID4)
Argument7:	U	U	U	U	U	U	U	U	(UID5)
Argument8:	U	U	U	U	U	U	U	U	(UID6)
Argument9:	U	U	U	U	U	U	U	U	(MSB, UID7)
Acknowledge:	1	F	F	F	F	F	F	X	(F = Status flags)

Data only follows if Read was successful

Reply1:	D	D	D	D	D	D	D	D	(D = LS Byte of data Read from ICODE tag)
Reply2:	D	D	D	D	D	D	D	D	
Reply3:	D	D	D	D	D	D	D	D	
Reply4:	D	D	D	D	D	D	D	D	(D = MS Byte of data Read from ICODE tag)

Label UID

Command to return label status and UID (Unique Identifier or "serial number") of single (dominant) label. The acknowledge byte flags indicate general Tag status. NOTE that if multiple labels are expected in the RF field then LABEL INVENTORY command must be used to acquire full UID list.

	B7		B0						
Command:	0	1	0	1	0	1	0	1	(Ascii "U", 0x55)
Acknowledge:	1	F	F	F	F	F	F	X	(F = Status flags)

Data only follows if label responded OK and UID is available.

Reply1:	U	U	U	U	U	U	U	U	(LSB, UID0)
Reply2:	U	U	U	U	U	U	U	U	(UID1)
Reply3:	U	U	U	U	U	U	U	U	(UID2)
Reply4:	U	U	U	U	U	U	U	U	(UID3)
Reply5:	U	U	U	U	U	U	U	U	(UID4)
Reply6:	U	U	U	U	U	U	U	U	(UID5)
Reply7:	U	U	U	U	U	U	U	U	(UID6)
Reply8:	U	U	U	U	U	U	U	U	(MSB, UID7)

Label INVENTORY

(Note: command not implemented on standard proximity system)

Command to return label status and list of UIDs (Unique Identifiers or "serial numbers"). Inventory command returns the number of tags present in the RF field (8 max) followed by UID data. Each UID is eight bytes long and is returned least significant byte first (UID0-UID7). The UID data sequence is contiguous groups of eight bytes, so host must use "Reply1" (number of UIDs) to ensure all data is received and stored (up to 66 bytes).

Command: B7 B0
 0 1 0 1 0 1 0 1 (Ascii "U", 0x55)

Acknowledge: 1 F F F F F F X (F = Status flags)

Data only follows if at least one label responds and UID is available.

Reply1: x x x x N N N N (N = number of UIDs following, maximum 8)
Reply2: U U U U U U U U (LSB, UID0)
Reply3: U U U U U U U U (UID1)
Reply4: U U U U U U U U (UID2)
Reply5: U U U U U U U U (UID3)
Reply6: U U U U U U U U (UID4)
Reply7: U U U U U U U U (UID5)
Reply8: U U U U U U U U (UID6)
Reply9: U U U U U U U U (MSB, UID7)



Reply58: U U U U U U U U (LSB, UID0)
Reply59: U U U U U U U U (UID1)
Reply60: U U U U U U U U (UID2)
Reply61: U U U U U U U U (UID3)
Reply62: U U U U U U U U (UID4)
Reply63: U U U U U U U U (UID5)
Reply64: U U U U U U U U (UID6)
Reply65: U U U U U U U U (MSB, UID7)

Command Protocol (ISO14443B Mode)

The following commands are supported in ISO14443B mode. The command code followed by optional data/arguments is sent to the MicroRWD. The RWD replies with an acknowledge code (which is made up of various status flags) followed by optional data. After the command (+ data) has been sent, the acknowledge code should be read back by the host and decoded to confirm that the command was received and actioned correctly. The serial bit protocol is 9600 baud 8 bits, 1 stop, no parity (lsb transmitted first).

The status flags returned in the Acknowledge byte are as follows:

b7	b6	b5	b4	b3	b2	b1	b0	
1	1	0	0	1	1	1	1	
								EEPROM error (Internal EEPROM write error)
								Card OK (Card serial number matched to identity code list)
								Rx OK (Card communication and acknowledgement OK)
								RS232 error (Host serial communication error)
								MFRC error (Internal or antenna fault)

Note that bit 7 is fixed so that the RWD acknowledge response to a valid host command would generally be 86 (Hex), indicating that a matched (or authorised) ISO14443B card is present.

Card UID

Command to return Card status and UID (Unique Identifier or "serial number") of the single (dominant) card. The acknowledge byte flags indicate general Tag status. Multiple ISO14443B cards in the field will cause a data collision and the RWD will return 0x80 status/acknowledge byte indicating NO card present.

	B7						B0	
Command:	0	1	0	1	0	1	0	1
								(Ascii "U", 0x55)
Acknowledge:	1	F	F	F	F	F	F	X
								(F = Status flags)

Data only follows if card responded OK and UID is available.

Reply1:	U	U	U	U	U	U	U	U	(LSB, UID0)
Reply2:	U	U	U	U	U	U	U	U	(UID1)
Reply3:	U	U	U	U	U	U	U	U	(UID2)
Reply4:	U	U	U	U	U	U	U	U	(MSB, UID3)

Notes for Commands (Mifare, ICODE, ISO14443B)

NOTE also that for the “Read Card Block” or “Card UID” command (or INVENTORY command), if an error flag has been set in the Acknowledge code then there will be NO following data.

NOTE that the serial communication uses hardware handshaking to inhibit the host from sending the Micro RWD commands while Card interrogation is in progress. The serial communication system and protocol allows for a 10ms ‘window’ every Card polling cycle indicated by the BUSY(CTS) line being low. During this ‘window’ the host must assert the first start bit and start transmitting data. The BUSY goes high again 10ms after the last stop bit is received. The host must therefore send the command and all the arguments with no gaps otherwise timeout will occur and BUSY goes high. NOTE that only one command sequence is handled at a time.

Method of Operation

The system works on a polling principle whereby the RF field is turned on for a short period to check if a card is present. Authentication and Read/Write operations can then be performed before the RF field is turned off again and the process repeats. A programmable polling delay period occurs after the RF is turned off and the microcontroller and RF circuitry is put into sleep and power-down modes during this time to achieve low average power consumption.

When a card is detected in the field a multi-pass handshaking procedure takes place where card information and serial number data is exchanged and checked for integrity. Once this procedure has completed successfully an individual card can be selected and is available for other operations.

The RWD itself has the additional feature of then checking the four byte Mifare/ISO14443B UID/serial number (or least significant four bytes of Ultralight/ICODE UID) against an internal authorisation list. The RWD internal EEPROM contains a list of four byte Identity codes (up to 60 of them) located from byte 12 onwards. If the list has FF FF FF FF (hex) stored at the first location (EEPROM bytes 12 - 15) then the list is treated as empty so the Identity code check is skipped.

Otherwise the card serial number is checked against all the entries in the list (until the FF FF FF FF termination code is reached) and if matched then the RWD allows the card to be accessed for other operations. If not the Red LED remains on and the card is blocked for further access. This is an additional level of security that can be used as a “mini access control” system for simple applications that only involve the serial number or where the Security Keys are not known.

For Mifare cards, once the RWD has selected the card and has matched the serial number against its internal list (or the list is empty) then the Read/Write (or Inc/Dec/Transfer) operations can be performed. These require an internal high-security Authentication Crypto algorithm to take place that use the supplied Security Keys to gain access to a particular sector. If the Key selected does not match the Key stored in the Mifare card sector then the operation fails and the Red LED is turned on again

So in summary, a card can be successfully selected but can be blocked by the RWD authorisation list and fail Read/Write operations because the Keys are incorrect. Even if the Security Key is incorrect the Serial number can still be read using the “Card UID” command.

For ICODE operation, when a label is in the RF field a handshaking procedure occurs and the RWD acquires the labels UID (Unique Identifier/serial number). The least significant four bytes of the UID (UID0 - UID3) are used to check against the internal authorisation list. For subsequent read/write operations, the labels are individually selected by including their UID in the command sequence. The principle of the RF field being ON only for label communication means that the label is effectively turned off and reselected each polling cycle. The assumption is therefore made that after the label UID has been acquired (using Label UID command), the label is still present for the next polling cycle.

Basic RWD Communication

For basic operation of the MicroRWD connected to a host computer, the RWD can either be polled or communication can be triggered by an interrupt signal (Green LED output). In either case for Mifare operation, the host would generally send the “STORE KEYS” command to load a custom security key into the RWD memory or simply use the pre-loaded default key values.

For a polling technique, the host computer would then keep sending the “STATUS” or “CARD UID” command and would monitor the acknowledgement code until a valid card was detected.

For the interrupt technique, the Green LED output can be used as an interrupt signal connected to the host computer. The Green LED output is normally high and goes low only when a valid card has been detected. This falling-edge signal can trigger a host interrupt to then send the “STATUS” or “CARD UID” command to determine the card type and serial number.

In both cases once a valid card has been detected a “READ BLOCK” or “WRITE BLOCK” command can be sent and the acknowledge code monitored to establish that the operation was successful.

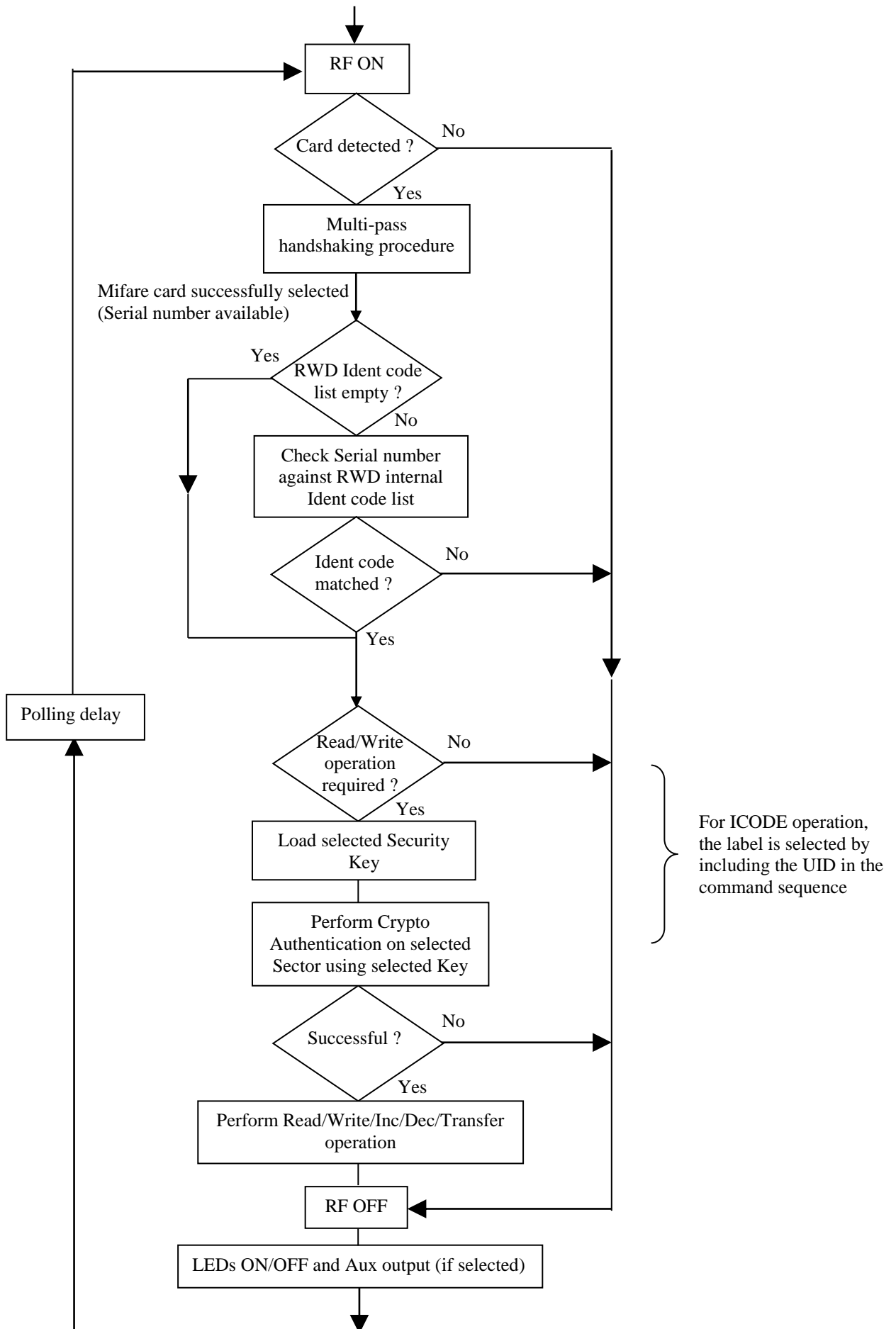

Auxiliary Asynchronous Serial output

If selected, data can be automatically output from the **OP0 or main TX** pin as 4-bytes of data transmitted asynchronously at 9600 baud, 8-bits, 1 stop-bit, no parity. The data source can be selected as the 4-byte UID (serial number), the least significant 4-bytes of a double UID or the least significant (first) 4-bytes of a card memory block.

Data bytes transmitted at 9600 baud, 8-bits, 1-stop bit, No parity (104 μ S per bit)

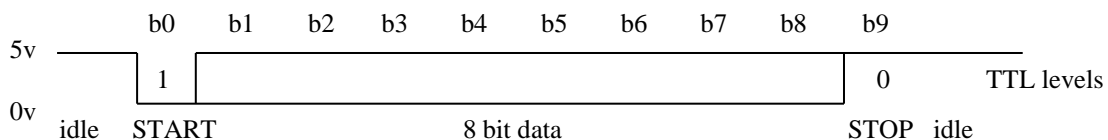

Auxiliary Wiegand Output Protocol

If selected, data can be automatically output from the **OP0 / OP1** pins as Data HIGH and Data LOW signals according to the Wiegand protocol.

The Wiegand protocol (24 bit data length) can be made up of a leading even parity bit (for b0 - b11), 24 bits of data (from transponder data) and a trailing odd parity bit (for b12- b23) creating a 26 bit output stream. The 32-bit mode has the same format except least significant four bytes of block data are used to form the data sequence. The parity bits are included or omitted and the byte order is reversed according to the EEPROM parameter settings.

For Example:-

Mifare block data (least significant 4 bytes): 0x04 60 22 12

(reversed byte option would use 0x12 22 60 04 as base data)

Wiegand 26 bit sequence:- E (b0 ----- b11) (b12 ----- b23) O

E (0 4 6 0 2 2) O

1 0000 0100 0110 0000 0010 0010 1

Where E is EVEN parity bit for bit 0 to 11 and O is ODD parity bit for bits 12 to 23

The base data for the Wiegand output can be the UID (least significant 4-bytes of serial number) acquired during the initial card communication or the least significant 4-bytes of data from a block of card memory (acquired by an internal Block Read operation). Selection is by means of an RWD EEPROM parameter.

For the “Mifare/ICODE” internal Block Read operation, the block number, key code number and type (KeyA or KeyB) are programmable EEPROM parameters. In addition, parameters control whether the base data byte order is reversed or if parity bits are added before output.

In this manner the user can select to use the UID (serial number) or user programmed information within a memory block as the base data for the Wiegand output. The complete data frame is output whenever the tag is within the RWD's antenna field and the tag has been validated. This output is independent of the normal TTL serial interface which responds to received commands and replies with the data as requested.

The physical Wiegand protocol is asynchronously transmitted as low going 50 μ S pulses on the appropriate DATA low or DATA high pins. These pulses are separated by 2mS periods. The Wiegand sequence is output a single time whenever a valid tag enters the RF field for the first time. (NO Wiegand output if AUX OUTPUT parameter is ZERO/OFF).

Wiegand Protocol Timing Diagram

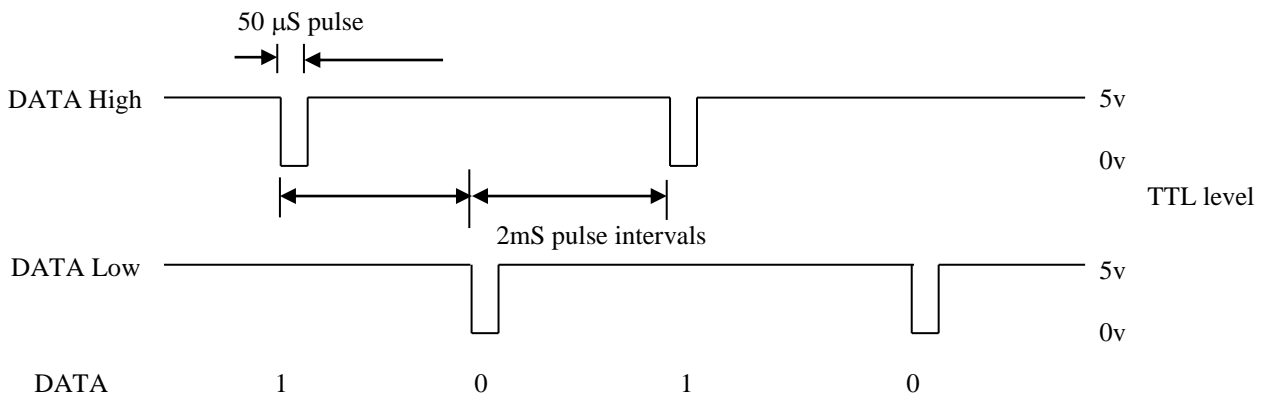

ICODE SLI (128 byte) Memory Map

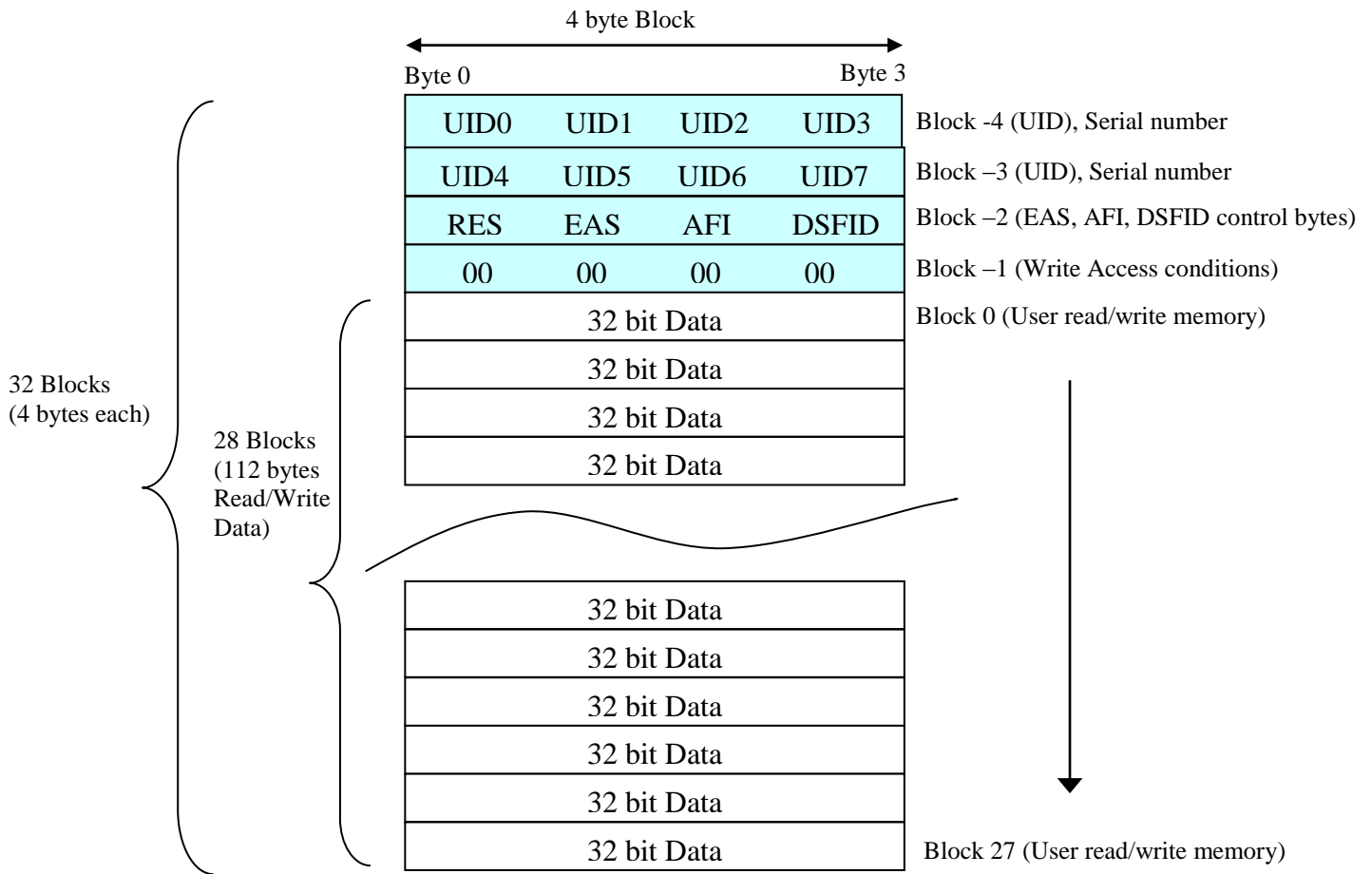

Note: ICODE SLI cards/labels have 128 bytes of memory of which 16 bytes (first four blocks) are only accessible using special commands. The eight byte UID (Serial number) is acquired by the RWD when the card/label is first detected and is read using the Card UID command.

ICODE SLI UID (Unique Identifier/Serial number)

Note that the numbering convention for displaying bits according to ISO15693 is to start with LSB and end with MSB rather than usual convention of bit numbering within a byte.

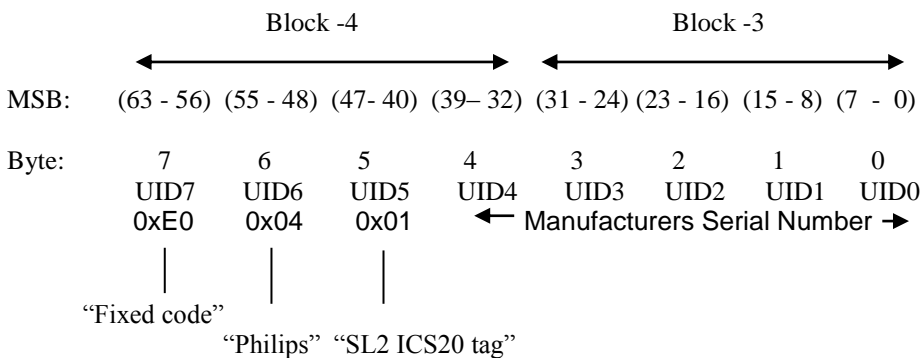

ib technology

ISO15693 defines that UID0 - UID5 (bits 0-47) contain the manufacturer serial number. (UID4 and UID5 can contain information on capacitor value, IC and customer identification).

UID6 = IC manufacturers code

ST = 0x02

Philips = 0x04

Infineon = 0x05

TI = 0x07

EM Marin = 0x16

UID7 = Fixed code = 0xE0

(The ICODE ident code is defined as the least significant four bytes of the 8 byte UID, effectively UID0 - UID3). Note that The UID used for the "Ident list" check is the first tag UID acquired by internally generated Inventory command.

Mifare 1k (1024 byte) Memory Map

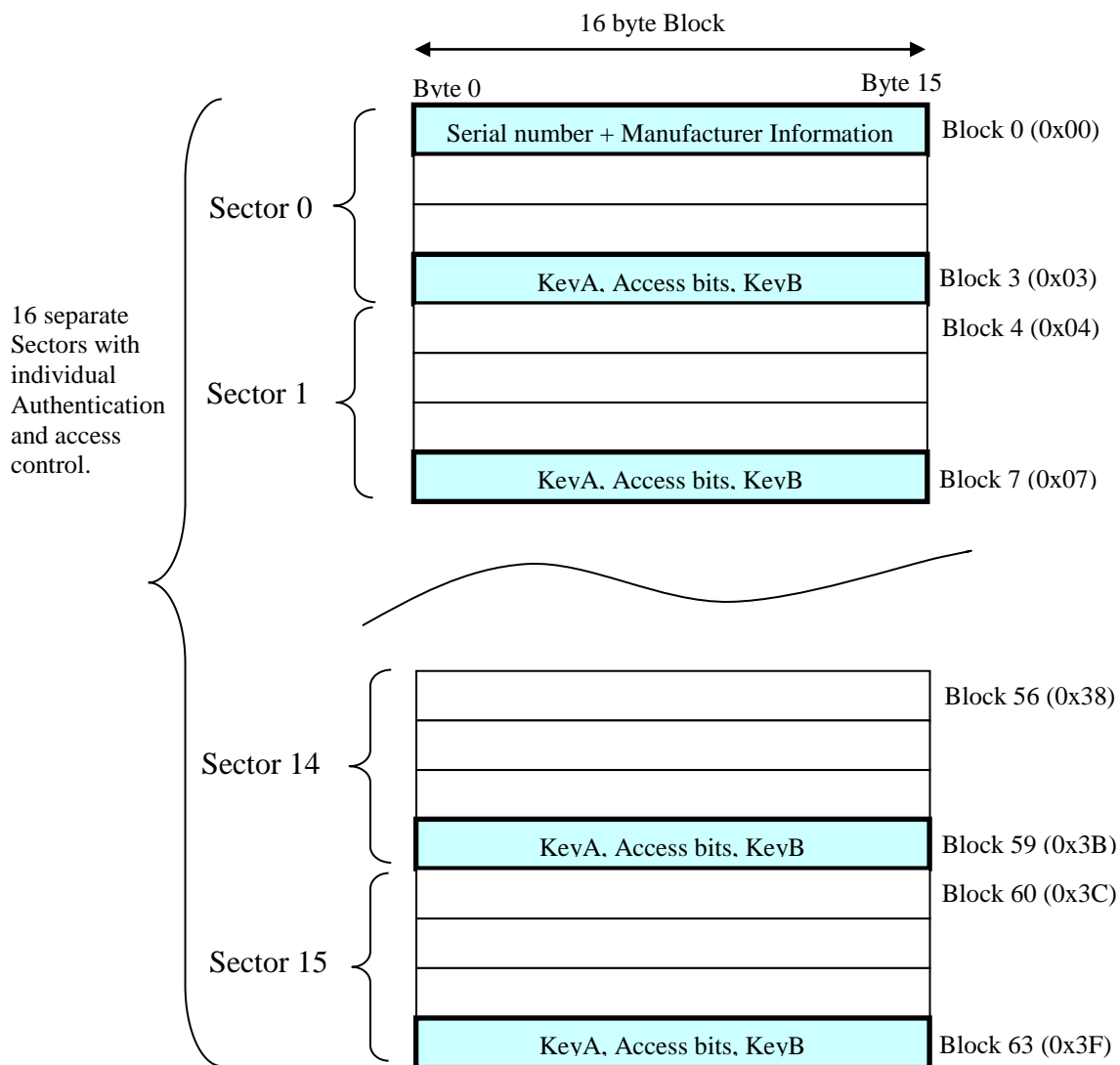

1024 byte memory is organised as sixteen sectors, each of which is made up of four blocks and each block is 16 bytes long. The first block in the memory (Block 0) is read-only and is set in the factory to contain the four-byte serial number (UID), check bytes and manufacturers data.

The last block of each sector (Blocks 3, 7, 11, 15.....59, 63) is the Sector Trailer Block which contains the two security Key codes (KeyA and KeyB) and the Access bits that define how the sector can be accessed

Taking into account the Serial Number/Manufacturers Block and the Sector Trailer Blocks then there are 752 bytes of free memory for user storage. For all Read and Write operations the Mifare card memory is addressed by Block number (in hexadecimal format).

Mifare 4k (4096 byte) Memory Map

(Lower 2k bytes, sectors 0-31 arranged as 32 x 4 block sectors)

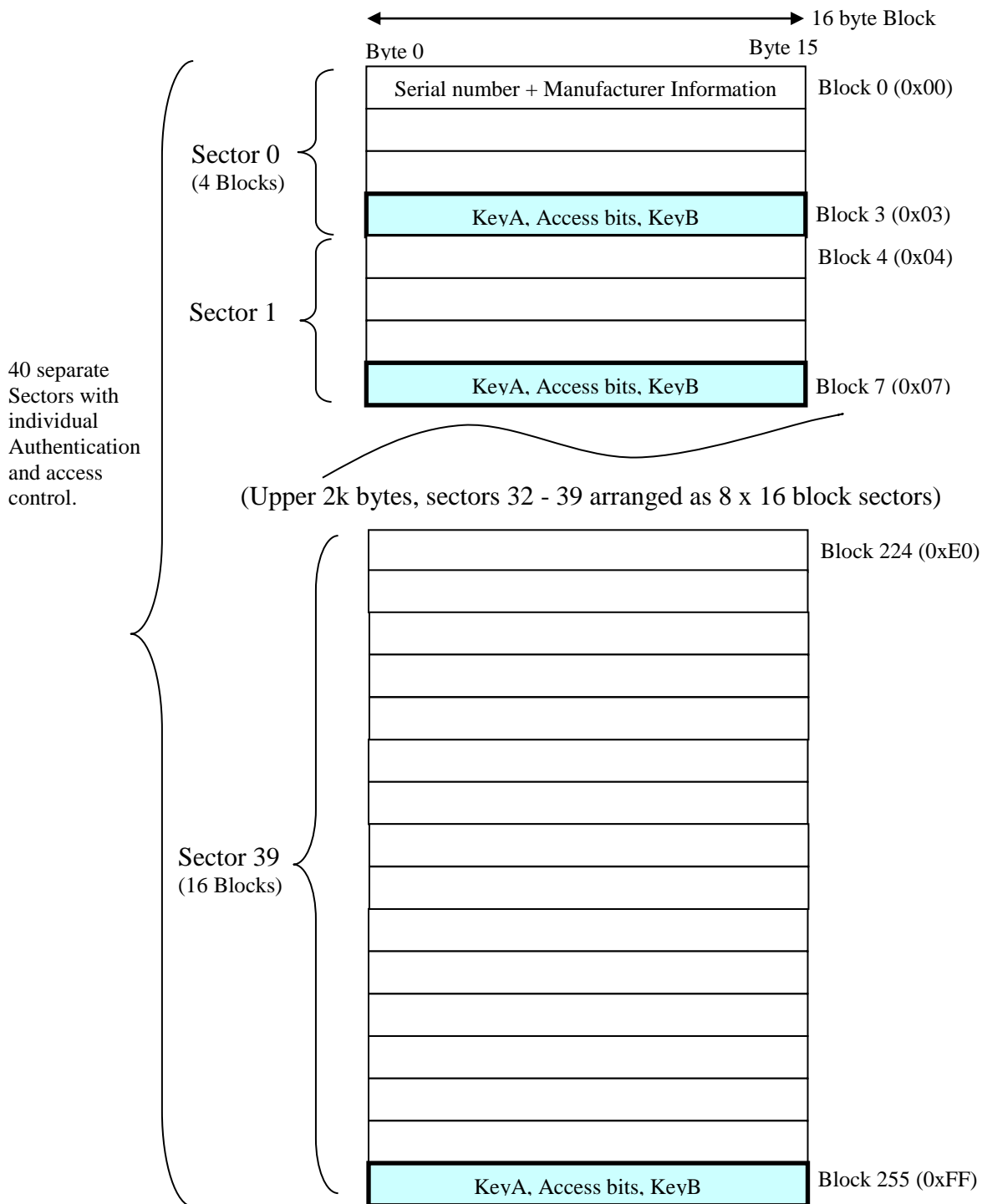

The lower 2048 bytes of the 4k card (sectors 0 – 31) are organised in the same way as the 1k card. However the upper 2048 bytes are organised as eight large sectors of 16 blocks each (sectors 32 – 39). Taking into account the Serial Number/Manufacturers Block and the Sector Trailer Blocks then there are 3440 bytes of free memory for user storage.

Manufacturer Block

The Manufacturer block is the first data block in Sector 0 and it contains the read-only serial number (UID – Unique Identifier) and the IC manufacture information.

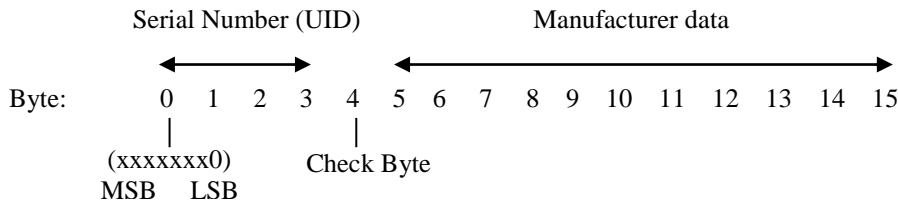

Data Blocks

Mifare sectors contain 3 blocks (1k card) or 15 blocks (upper half of 4k card) of 16 data bytes (except Sector 0 that has Manufacturer Block and 2 data blocks). Data blocks can be configured as standard read/write memory or “Value Blocks” for special electronic-purse operations. “Value Blocks” can use additional commands such as Increment and Decrement for direct control of the data field, they have a fixed data format which permits error detection/correction and backup management. “VALUE” is a signed four byte integer (2’s complement format) and is stored three times, twice non-inverted and once inverted. “ADR” signifies a one byte address that can be used to store the block number. “ADR” is stored four times, twice inverted and twice non-inverted.

Data Block

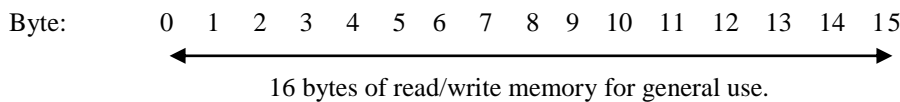

Value Block

Example format for value = 100 decimal (0x64), at block address 0.

(Value data stored LS byte first, ADR = block address, $\overline{\text{ADR}}$ = inverted block address)

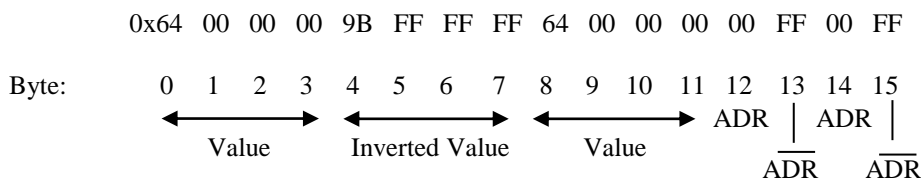

Note that the ADR and inverted ADR block address is part of the required format for the Value Data Structure BUT it is not changed by the Inc, Dec or Transfer commands and exists to allow optional storage of block numbers. For general use, the 0x00 address and 0xFF inverted address can be used to satisfy the structure format. The Inc, Dec and Transfer commands first check the structure format before beginning the operations and the commands fail if the format is not correct.

Value Data Structures must first be formatted as above using a WRITE Block command before INC, DEC or TRANSFER commands can be used.

Sector Trailer Block

The last block of each sector (Blocks 3, 7, 11, 15.....59, 63 etc) is the Sector Trailer Block which contains the two security Key codes (KeyA and KeyB) and the Access bits that define how the data blocks can be accessed (Read/Write, Read or Write only, as data or Value blocks and using which key). If KeyB is not used then the last 6 bytes of the Sector Trailer Block can be used for general data storage. Byte 9 (last byte of Access bits) is not used and can also be used for general storage. Note that the KeyA (and KeyB) value read back as logical 0's to ensure system security.

IT IS STRONGLY RECOMMENDED THAT THE KEY CODES AND THE ACCESS BITS STORED ON THE MIFARE CARD ARE NOT CHANGED UNTIL THEIR OPERATION IS FULLY UNDERSTOOD.

Sector Trailer Block

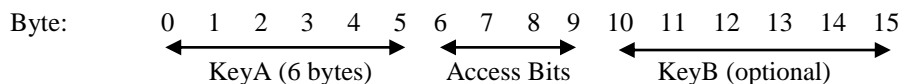

KeyA and KeyB

The security Key codes are each six bytes long and for successful authentication and read/write communication the RWD device would have to have one or both keys stored in its internal memory as well (depending on Access Bit settings). To allow “out-of-the-box” operation with new Mifare transponders and RWD devices, Transport Key values are pre-loaded into the transponder memory and also into the RWD memory.

Transport Key values as defined by Infineon are:

KeyA: 0xFF FF FF FF FF FF **KeyB:** 0xFF FF FF FF FF FF

Transport Key values as defined by Philips Semiconductors are:

KeyA: 0xA0 A1 A2 A3 A4 A5 **KeyB:** 0xB0 B1 B2 B3 B4 B5

These KeyA and KeyB values are stored as repeated pairs in the MicroRWD MF device as a factory default.

If the user intends using other Mifare cards then they may have different transport keys loaded so the user would have to use the STORE KEY command to load the particular Key codes into the RWD memory first. Once correct communication is established then Keys and Access bits can be changed on the card and RWD to suit the users final system requirements.

Access Bits

The access conditions for every data block and sector trailer are defined by three bits (C1, C2, C3), which are stored in a specific non-inverted and inverted pattern in the sector trailer of the particular sector. The access bits control the memory access rights using the secret KeyA and KeyB codes. The access bits can be changed provided the relevant Key(s) is known and the current access conditions allow this operation.

Note that with each memory access the internal logic of the Mifare transponder verifies the format of the access conditions. If it detects a format error then the entire sector is irreversibly locked. Since the access bits themselves can be blocked for read/write operations, care must be taken when cards are being personalised for a particular application or service provider.

Access Bits	Block Affected within a sector	
	(1k card and lower half of 4k card)	(Upper half of 4k card)
C1 ₀ C2 ₀ C3 ₀	Block 0 (Data Block)	Blocks 0-4 (Data Blocks)
C1 ₁ C2 ₁ C3 ₁	Block 1 (Data Block)	Blocks 5-9 (Data Blocks)
C1 ₂ C2 ₂ C3 ₂	Block 2 (Data Block)	Blocks 10-14 (Data Blocks)
C1 ₃ C2 ₃ C3 ₃	Block 3 (Sector Trailer)	Block 15 (Sector Trailer)

Note that the Access Conditions for individual blocks can be set on 1k cards and for lower half of 4k card memory. However for the upper half of 4k cards the Access conditions are set for groups of five blocks (except for Sector Trailer Block which is still individually set).

Access Conditions

The C1, C2, C3 access bits are stored in a specific non-inverted and inverted pattern in the sector trailer of the particular sector. These bits control the Access Conditions for every data block and sector trailer block.

Sector Trailer Block

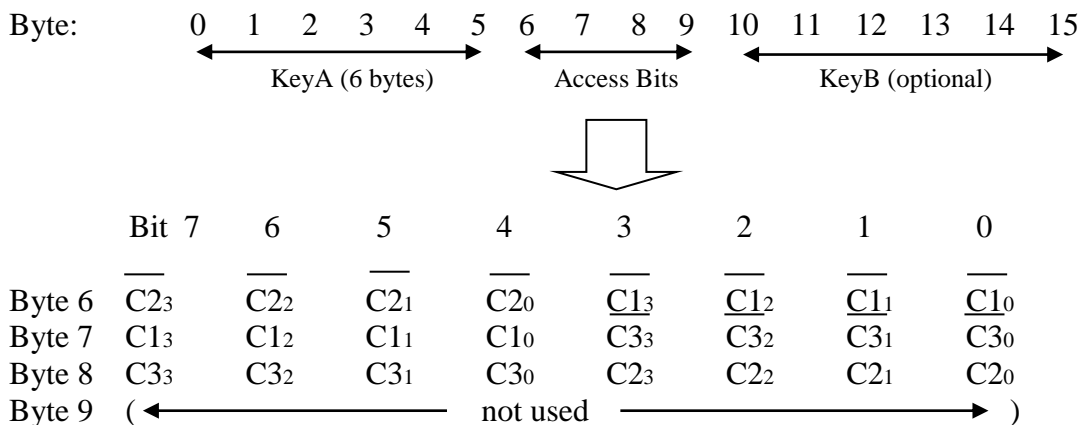

C_{xy} = Inverted bit

Transport settings (factory defaults)

Byte 6	(1	1	1	1	1	1	1	1)	= 0xFF
Byte 7	0	0	0	0	0	1	1	1)	= 0x07
Byte 8	1	0	0	0	0	0	0	0)	= 0x80
Byte 9	←				not used	→			

Access Condition for Sector Trailer Block

The read/write access to the Keys and the Access Bits themselves is controlled by the access conditions for the Sector Trailer Block. The read/write access is specified as “Never”, “KeyA”, KeyB” or Key A|B (KeyA OR KeyB).

Access Bits			Access condition for:							
C1	C2	C3	KEY A		ACCESS BITS		KEY B			
			Read	Write	Read	Write	Read	Write		
0	0	0	never	keyA	keyA	never	keyA	keyA	(KeyB can be read)	
0	0	1	never	keyA	keyA	keyA	keyA	keyA	(Transport setting)	
0	1	0	never	never	keyA	never	keyA	never	(KeyB can be read)	
0	1	1	never	keyB	keyA B	keyB	never	keyB		
1	0	0	never	keyB	keyA B	never	never	keyB		
1	0	1	never	never	keyA B	keyB	never	never		
1	1	0	never	never	keyA B	never	never	never		
1	1	1	never	never	keyA B	never	never	never		

The new Mifare cards have the access conditions predefined as transport configuration:

C1 C2 C3 = (0 0 1) which means Sector Trailer Block can only be read or written to using KeyA and KeyA itself can never be read.

Because the Access Bits themselves can be locked great care must be taken when any of these settings are changed because they may be irreversible making the card unusable.

Access Condition for data areas

The read/write access to the data areas is also controlled by the access conditions defined in the Sector Trailer Block. The read/write access is specified as “Never”, “KeyA”, KeyB” or Key A|B (KeyA OR KeyB).

A data block can be a “read/write block” or a “value block”. For a “read/write” block the basic read and write operations are allowed. For the “value block” the additional increment, decrement, transfer and restore operations can apply. In one case (001) only read and decrement are possible for a “non-rechargeable” card application and in another case (110) recharging is only possible using keyB.

The default transport configuration specifies that the data areas can only be accessed using KeyA|B, however the operation of the Mifare cards define that “IF KEYB CAN BE READ IN THE CORRESPONDING SECTOR TRAILER THEN IT CANNOT SERVE FOR AUTHENTICATION”. This means that for the transport configuration (and 001 and 010 cases), KeyA must be used for access.

Note also that the read-only status of the Manufacturer Block is not affected by the access bits setting.

Mifare Ultralight (64 byte) Memory Map

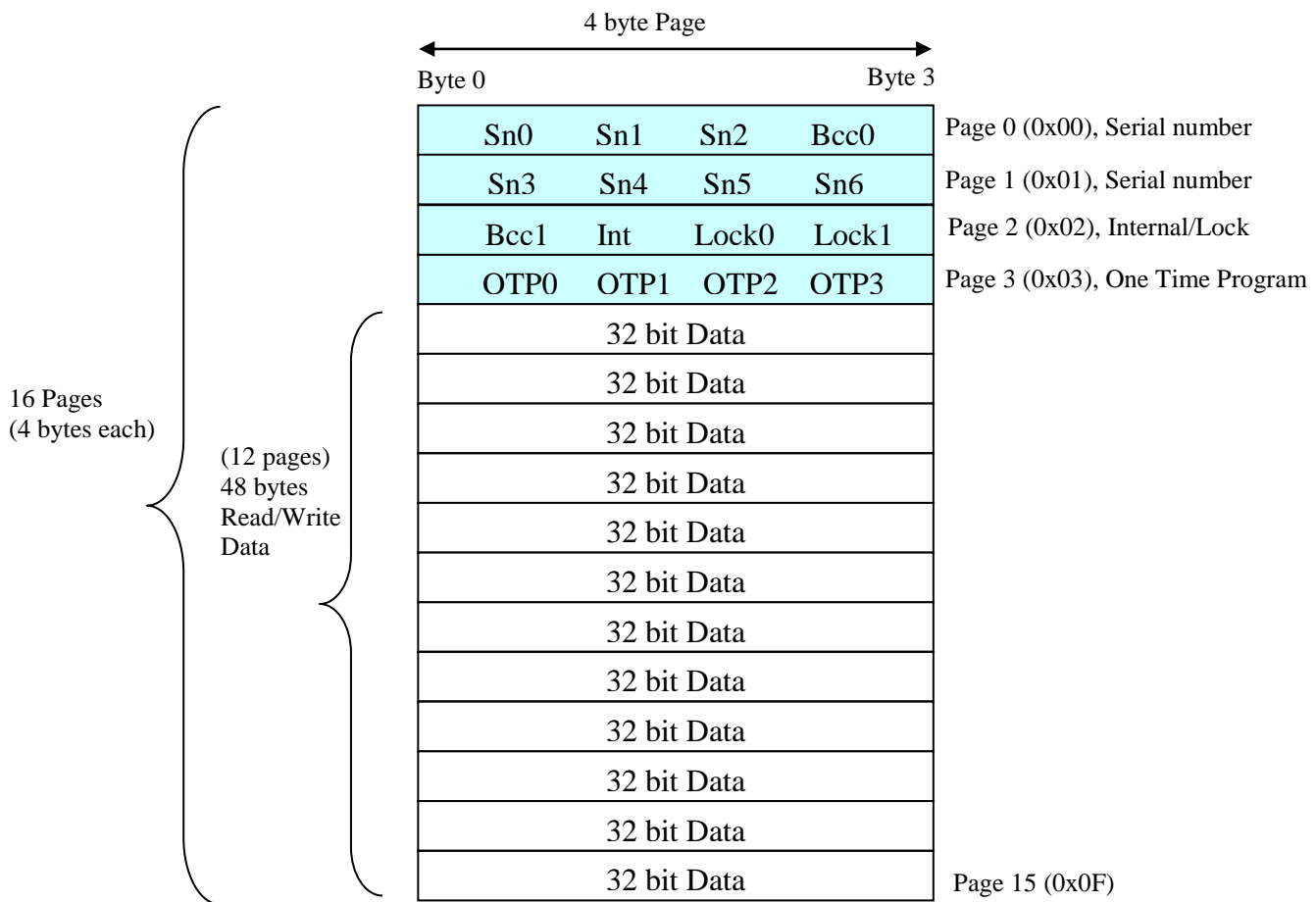

Note: Ultralight card has 7 byte serial number (+ 2 check bytes)
 $Bcc0 = CT \text{ xor } Sn0 \text{ xor } Sn1 \text{ xor } Sn2$ (CT = Cascade Tag = 0x88)
 $Bcc1 = Sn3 \text{ xor } Sn4 \text{ xor } Sn5 \text{ xor } Sn6$

The Mifare Ultralight transponder has a different structure to the standard 1k and 4k byte Mifare transponders. The 64 byte memory is organised as sixteen pages of four bytes each. The first two pages (and byte 0 of page 3) contain a seven byte serial number (UID) together with two check bytes. The other “system” bytes are used for locking card features and providing a number of OTP (One Time Programmable) data bytes. The remaining 12 pages (48 bytes) can be used for general read/write storage.

Despite having a different memory structure, the Ultralight uses the same Mifare communication protocol except that a cascaded selection procedure is used and the **Authentication procedure is not used for read/write operations.** The security Keys are therefore NOT required for any operations to an Ultralight card. Because of its smaller memory, more basic operation and lower cost, the Ultralight card is typically used for low-value single applications.

The MicroRWD MF reader module fully supports the Ultralight cards and the read and write commands have the same format as for the standard cards except that dummy data bytes (0x00 values) are used for the Key number etc. In addition the “block number” argument becomes a “page number” parameter.

Mifare Applications and Security

The Mifare “classic” family is the pioneer and market leader in contactless smart card technology operating in the 13.56 MHz frequency range with read/write capability. The Mifare technology was originally designed for Electronic-Purse applications for public transport systems and was a benchmark for the ISO 14443A standard. The cards have up to 40 separate memory sectors or “purses” (on Mifare 4k card) that can be individually locked and unlocked for access. In addition, the high speed communication of the 13.56 MHz interface allows for quick increment/decrement operations that are required for rapid ticketing or e-purse applications. Typical transaction time is less than 100ms for read/modify/write operations. The multiple memory sectors allow for different service providers to use the same Mifare card with complete independence and security, the Ultralight card has only one sector and is designed for single use or disposable applications due to its low cost.

Because Mifare was designed originally for Electronic-Purse applications, a very high level of security was essential to prevent fraud. Each transaction is started with a mutual three-pass authentication procedure according to the ISO 9798-2 standard. RF communication is protected from replay attack and data communication between RWD and card is encrypted according to the Philips/NXP triple-DES CRYPTO1 algorithm. Separate sets of two security keys for each memory sector (or application) ensure that service providers have complete security control over their individual sector. The high level of data integrity for the 106 kbaud RF communication is achieved by combining a special patented modulation technique, 16 bit CRC, parity bit coding, bit counting, channel monitoring and an anticollision algorithm.

Finally, the RWD device itself stores up to 32 security keys that the service provider can change and use for their applications. These keys are non-volatile and cannot be read back further ensuring system security.

IB Technology’s design philosophy has created the “Universal RFID Socket” so that different products such as the 125 kHz MicroRWD (Hitag and EM Marin) modules, QT (Quad Tag) module and the 13.56 MHz MicroRWD Mifare - ICODE modules are pin compatible and share the same host command structure. This concept allows simple evaluation and use of different RFID Readers so that users can migrate between radically different technologies with the minimum of effort.

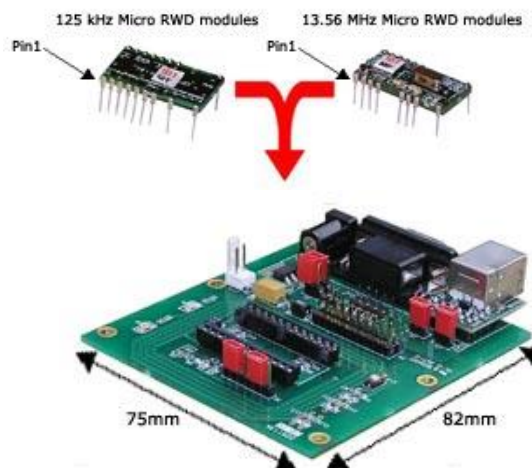

The same firmware is also used on the OEM Reader boards that have on-board PCB track antenna, LEDs and RS232 or USB interfaces.



OEM-MIFARE-ICODE-RS232



OEM-MIFARE-ICODE-USB

All products are available as “Reference Design Packs” so higher volume customers can copy a design and just purchase a pre-programmed microcontroller. Benefits are a proven, quick time-to-market Reader product with minimum engineering effort at minimum cost.

Micro RWD MF-IC (low-power) specification

The MicroRWD MF-IC (low-power) version is a complete read/write system for 13.56 MHz Mifare 1k, 4k, Ultralight and ICODE/Tag-it cards and tags. ISO14443B card types are supported for serial number acquisition only.

Specifically, the LOW-POWER version has been designed to operate over a wider voltage range (but optimised for 5-volt operation) and have very low average current consumption making it ideal for battery applications. SLEEP and power-down modes are used extensively during the polling delay period to achieve this.

Parameter	Typical Value
Supply Voltage (performance optimised for 5 volt operation)	4 – 6 volts DC (operation from 4 x alkaline cells)
Operating temperature	-40 deg C to + 85 deg C
AVERAGE current consumption. (1 second polling)	Less than 150 μA
Active period for RF AND host communication (each polling cycle).	Up to 20 mS
Peak antenna voltage (optimum tuning)	30 volts peak-to-peak
Peak antenna current (optimum tuning) for short period each polling cycle (up to 10 mS burst)	150 mA
Polling Delay (SLEEP / Power-down mode)	0 to 8 seconds
Current consumption during Polling delay / SLEEP	Less than 20 μ A
Current consumption during RF ON each polling cycle	Less than 20mA
Maximum data rate (between card and RWD)	106k baud
Range (dependent on antenna dimensions and tuning)	25-50 mm
Auxiliary output drives	Up to 25mA
Serial Interface	TTL level RS232
Serial Communication Parameters	9600 baud, 8 data bits, no parity, 1 stop bit protocol with CTS handshake

Basic electrical specification with LED pins and auxiliary outputs NOT connected.
 During the “Polling Delay” SLEEP/Power-down period the logic levels on the RWD pins remain active and so for minimum current consumption, the LEDs and the auxiliary output drives must be disconnected (and the Beep output delay set to zero).

Micro RWD MF-IC module dimensions and pinout

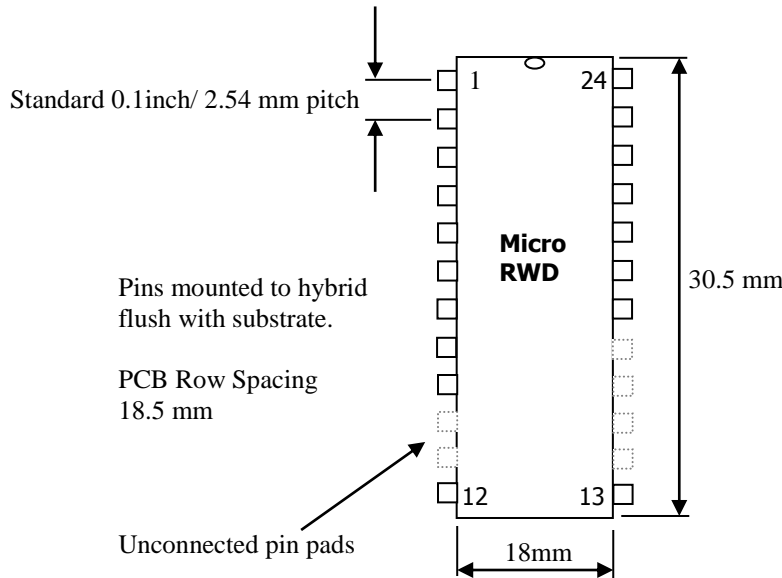

Minimum height occupied by module above host PCB : 10mm +/- 5%

PINOUT DESCRIPTION

Pin Name	DIP No.	I/O Type	Buffer Type	Description
LED1	1	O	TTL	Red LED connection. 25ma max sink current
LED2	2	O	TTL	Green LED connection. 25ma max sink current
RESET	3	I	ST	Reset pin internally pulled high. Active low. Normally not connected
BEEP	4	O	TTL	BEEP output pin (active LOW), 25ma max sink current
-	5	-	-	Not connected
-	6	-	-	Not connected
GND	7	P	-	Ground reference for logic and analogue pins
VCC	8	P	-	+5v Positive supply
AN1	9	P	AN	Antenna connection. 1 (connected to Mifare antenna board)
-	10	-	-	Not connected
-	11	-	-	Not connected
AN2	12	P	AN	Antenna connection 2 (connected to Mifare antenna board)
GND	13	P	-	Ground reference for logic and analogue pins.
-	14	-	-	Not connected
-	15	-	-	Not connected
-	16	-	-	Not connected
-	17	-	-	Not connected
-	18	-	-	Not connected
OP1	19	O	TTL	Auxiliary output drive. 25ma max sink current.
OP0	20	O	TTL	Auxiliary output drive. 25ma max sink current.
VCC	21	P	-	+5v Positive supply
RX	22	I	TTL	Serial communication Receive line. 9600 baud, 8 bit, 1 stop, no parity
TX	23	O	TTL	Serial communication Transmit line
CTS	24	O	TTL	Serial communication CTS handshake. RX enabled when CTS low and disabled when high.

(I/O = Input/Output, AN = Antenna output, P = Power, ST = Schmitt Trigger input, TTL = TTL logic I/O)

PIC microcontroller pin-out for “Reference Design” Applications

(Please also refer to the “Reference Design Pack” datasheet information)

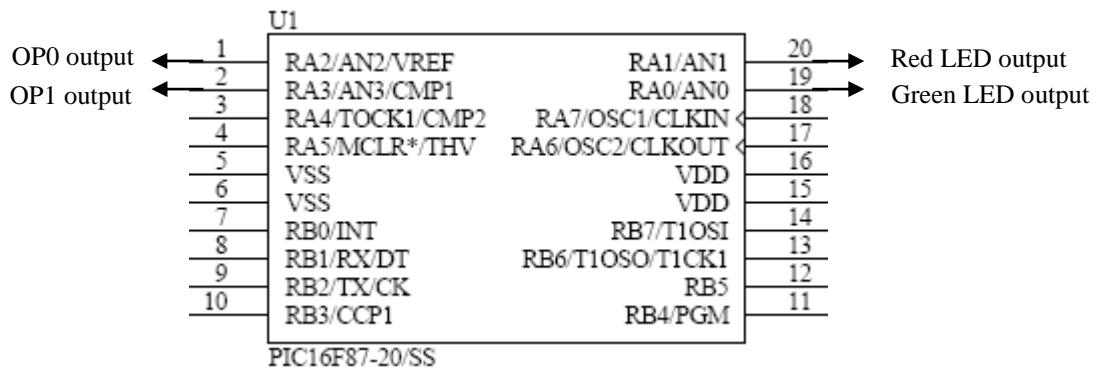

Device Pin-out Descriptions

U1 - PIC 16F87-I/SS			
Pin	Description	Pin	Description
1	RA2 – OP0 output	20	RA1 – Red LED output
2	RA3 – OP1 output	19	RA0 – Green LED output
3	RA4/RTCC – BEEP o/p	18	OSC1
4	MCLR – RST	17	OSC2 – OSCIN
5	VSS (GND)	16	VDD (+5v)
6	VSS (GND)	15	VDD (+5v)
7	RB0 – MOSI	14	RB7 – RX
8	RB1 – MISO	13	RB6 – TX
9	RB2 – NSS	12	RB5 – CTS
10	RB3 – SCLK	11	RB4 – RSTPD

(HITAG, MIFARE and ICODE are registered trademarks of Philips/NXP Semiconductors)
(Calypso is a registered trademark of Calypso Networks Association / CNA)

No responsibility is taken for the method of integration or final use of Micro RWD

More information on the Micro RWD and other products can be found at the Internet web site:

<http://www.ibtechnology.co.uk>

Or alternatively contact IB Technology by email at:

sales@ibtechnology.co.uk